

SPECTRAL GEOMETRY AND ASYMPTOTICALLY CONIC  
CONVERGENCE

A DISSERTATION  
SUBMITTED TO THE DEPARTMENT OF MATHEMATICS  
AND THE COMMITTEE ON GRADUATE STUDIES  
OF STANFORD UNIVERSITY  
IN PARTIAL FULFILLMENT OF THE REQUIREMENTS  
FOR THE DEGREE OF  
DOCTOR OF PHILOSOPHY

Julie Marie Rowlett  
June, 2006

© Copyright by Julie Marie Rowlett 2006  
All Rights Reserved

I certify that I have read this dissertation and that, in my opinion, it is fully adequate in scope and quality as a dissertation for the degree of Doctor of Philosophy.

---

Rafe Mazzeo Principal Adviser

I certify that I have read this dissertation and that, in my opinion, it is fully adequate in scope and quality as a dissertation for the degree of Doctor of Philosophy.

---

Richard Schoen

I certify that I have read this dissertation and that, in my opinion, it is fully adequate in scope and quality as a dissertation for the degree of Doctor of Philosophy.

---

Andras Vasy

Approved for the University Committee on Graduate Studies.

# Abstract

This work is in Differential Geometry and Analysis. The geometric setting is a family of smooth Riemannian metrics that degenerate to have an isolated conic singularity. This degeneration will be known as *asymptotically conic (ac) convergence*. The definition involves: a family of smooth metrics on a compact manifold, a conic metric on a compact manifold, and an asymptotically conic metric, also known as a scattering metric. In the geometric setting of ac convergence, we prove the following analytic results.

- Preliminary Result: The convergence of the spectrum and eigenfunctions of the scalar Laplacian.
- Main Result: The convergence of the heat kernels for geometric Laplacians and precise asymptotic behavior.

These results are obtained using pseudodifferential techniques and manifolds with corners constructed by a new type of blow up procedure called *resolution blow up*.

# Acknowledgements

I would like to thank my advisor, Rafe Mazzeo, for his excellent advice and support; Andras Vasy for his careful reading and helpful conversations; Tarn Adams for his writing advice; Henry Segerman for proper English; Michelle Rowlett and Lindy Van Sickle for reading and editing and all my family and friends for their patience and encouragement.

# Contents

Abstract	iv
Acknowledgements	v
<b>1 Spectral Convergence</b>	<b>1</b>
1.1 Introduction . . . . .	1
1.1.1 Background . . . . .	2
1.2 Geometric Preliminaries . . . . .	4
1.8 Analytic Preliminaries . . . . .	14
1.12 Spectral Convergence . . . . .	20
1.15 Proof Step 1: Accumulation $\sigma(\Delta_\epsilon) \subset \sigma(\Delta_0)$ . . . . .	21
1.15.1 Case 1: $w_j(p_j) \rightarrow c > 0$ as $j \rightarrow \infty$ . . . . .	22
1.15.2 Case 2: $w_j(p_j) = \mathcal{O}(\epsilon_j)$ as $j \rightarrow \infty$ . . . . .	22
1.15.3 Case 3: $\frac{\epsilon_j}{w_j(p_j)} \rightarrow 0$ as $j \rightarrow \infty$ . . . . .	23
1.16 Proof Step 2: $\sigma(\Delta_0) \subset$ Accumulation $\sigma(\Delta_\epsilon)$ . . . . .	25
1.17 Proof Step 3: Correct Multiplicities . . . . .	28
<b>2 Heat Kernels</b>	<b>29</b>
2.1 Heat Kernel for a Smooth, Compact Manifold . . . . .	29
2.1.1 The Heat Space for a Smooth, Compact Manifold . . . . .	30
2.1.2 The Smooth, Compact Heat Calculus . . . . .	31
2.4 $b$ -Heat Kernel . . . . .	33
2.4.1 $b$ -Geometry and $b$ -Operators . . . . .	33
2.4.2 The $b$ -Heat Kernel . . . . .	35

2.7	The Conic Heat Kernel . . . . .	38
2.7.1	The Conic Heat Space . . . . .	38
2.7.2	Conic Heat Kernel First Approximation . . . . .	41
2.7.3	The Conic Heat Calculus . . . . .	46
2.13	AC Heat Kernel . . . . .	61
2.13.1	The AC Heat Space . . . . .	62
2.13.2	AC Heat Calculus . . . . .	65
<b>3</b>	<b>Heat Kernel Convergence</b>	<b>74</b>
3.1	Introduction . . . . .	74
3.2	Preliminary Geometric Constructions . . . . .	74
3.2.1	The ACC Single Space Revisited . . . . .	74
3.2.2	The ACC Double Space . . . . .	78
3.3	The Asymptotically Conic Convergence (ACC) Heat Space . . . . .	82
3.4	The ACC Heat Calculus . . . . .	86
3.7	ACC Heat Kernel Convergence . . . . .	89
<b>A</b>	<b>Scalar Heat Kernel on the Exact Cone</b>	<b>99</b>
A.1	Geometric Preliminaries . . . . .	99
A.2	Analytic Preliminaries . . . . .	101
A.2.1	Technical Lemmas . . . . .	101
A.4.1	Special Functions . . . . .	105
A.5	Conic Heat Kernel Asymptotics . . . . .	107
	<b>Bibliography</b>	<b>113</b>

# List of Figures

1.1	Manifold with isolated conic singularity and associated manifold with boundary. . . . .	6
1.2	Resolution blow up patching. . . . .	9
1.3	Ac convergence example: hyperboloids of revolution . . . . .	12
1.4	Acc single space: hyperboloid example . . . . .	13
1.5	The $b$ -double space . . . . .	17
2.1	The $b$ -heat space. . . . .	36
2.2	Construction of the conic heat space: $M_+^2$ . . . . .	40
2.3	The conic heat space, $M_{0,h}^2$ . . . . .	42
2.4	The ac double space. . . . .	63
2.5	The ac heat space. . . . .	64
3.1	Construction of the acc single space: $\mathcal{S}_c$ . . . . .	75
3.2	Acc single space . . . . .	77
3.3	Acc single space: submanifold diffeomorphic to truncated cone over $\bar{Z}$ . . . . .	78
3.4	The acc double space. . . . .	80
3.5	Schematic diagram of acc heat space $\epsilon = 0$ faces and corners. . . . .	84
3.6	The ac $b$ -heat space, $\bar{Z}_{b,h}^2$ . . . . .	85



# Chapter 1

## Spectral Convergence

### 1.1 Introduction

The spectrum of the Laplacian on a Riemannian manifold provides rich information on the geometry and topology of the manifold. The Laplacian has nice analytic properties; it is a second order elliptic partial differential operator. Associated to the Laplacian is a parabolic heat operator and the Schwartz kernel of its inverse, the heat kernel. This work focuses on the spectral geometry of manifolds with isolated conic singularities. We consider a smooth family of Riemannian metrics which converge *asymptotically conically* to a manifold with isolated conic singularity. We analyze the behavior of the Laplacian and its heat kernel as the smooth metrics converge to the conic metric to better understand the spectral geometry of manifolds with isolated conic singularities.

Before describing the degenerating family of metrics and the way in which they converge to a conic metric,<sup>1</sup> we briefly discuss results obtained by other authors in similar contexts.

---

<sup>1</sup>By which we mean a smooth, incomplete manifold with an isolated conic singularity, compact when completed as a metric space by adding the cone point.

### 1.1.1 Background

Cheeger and Colding wrote a series of three papers between 1997 and 2000 on the Gromov-Hausdorff limits of families of smooth, connected Riemannian manifolds with lower Ricci curvature bounds [4], [5], [6]. They proved Fukaya's conjecture of 1987 [8]: that on any pointed Gromov-Hausdorff limit space  $M_\infty$  of a family  $\{M_i^n\}$  of connected Riemannian manifolds with Ricci curvature bounded below, a self adjoint extension of the scalar Laplacian on  $M_\infty$  can be defined with discrete spectrum. They also proved that the eigenvalues and eigenfunctions of the scalar Laplacians  $\Delta_i$  converge to those on  $M_\infty$ . An example, provided by Perelman, showed that the results of Cheeger and Colding could not be extended to the Laplacian on forms or to more general geometric Laplacians. In 2002, Ding proved convergence of the heat kernels and Green's functions in the same setting. The estimates are uniform for time bounded strictly away from zero. These results are impressive in that the only hypothesis on the manifolds is the lower Ricci curvature bound. It would be useful to prove a more general spectral convergence result for the geometric Laplacian and to obtain uniform estimates on the heat kernels for all time. In order to obtain such results, it becomes necessary to impose more structure on the manifolds and the way in which they converge to a singular limit space.

In the 1990 thesis of McDonald [23] strong analytic results were proven for manifolds converging to a singular metric in a restrictive manner. Let  $M$  be a fixed compact manifold with a Riemannian metric and  $H$  an embedded orientable hypersurface with defining function  $x$  and smooth metric  $g_H$ . The family of degenerating metrics on  $M$  being considered is

$$(\epsilon^2 + x^2)g_H + dx^2 \quad \epsilon \in [0, 1).$$

Here, as  $\epsilon \rightarrow 0$ , the metric converges to

$$g_o = x^2 g_H + dx^2,$$

which has an isolated conic singularity at  $x = 0$ . Geometrically, the manifold is

being pinched along the hypersurface  $H$  and the resulting manifold has a conic singularity as  $x \rightarrow 0$ . McDonald constructed a parameter ( $\epsilon$ ) dependent operator calculus and studied the behavior of the Laplacian and heat kernel as  $\epsilon \rightarrow 0$ .

In 1995, Mazzeo and Melrose developed pseudodifferential techniques to describe the behavior of the spectrum under another specific type of metric collapse, known as *analytic surgery*, similar to the conic collapse considered by McDonald. Let  $(M, h)$  be an odd dimensional compact spin manifold in which  $H$  is an embedded hypersurface with quadratic defining function  $x^2 \in \mathcal{C}^\infty(M)$ . Let  $\partial_\epsilon$  be the Dirac operator associated to the metric

$$g_\epsilon = \frac{|dx|^2}{x^2 + \epsilon^2} + h,$$

where  $\epsilon > 0$  is a parameter. The limiting metric  $g_0$  with  $\epsilon = 0$ , is an exact  $b$ -metric on the compact manifold with boundary  $\bar{M}$  obtained by cutting  $M$  along  $H$  and compactifying as a manifold with boundary, hence the name, *analytic surgery*. In other words, it gives  $M - H$  asymptotically cylindrical ends with cross section  $\partial\bar{M}$ , a double cover of  $H$ , and has the form

$$g_o = \frac{|dx|^2}{x^2} + h.$$

Under the assumption that the induced Dirac operator on this double cover is invertible, Mazzeo and Melrose showed that

$$\eta(\partial_\epsilon) = \eta_b(\partial_{\bar{M}}) + r_1(\epsilon) + r_2(\epsilon) \log \epsilon + \tilde{\eta}(\epsilon),$$

where  $\eta_b(\partial_{\bar{M}})$  is the  $b$ -version of the eta invariant introduced by Melrose,  $r_i$  are smooth and vanish at  $\epsilon = 0$  and are integrals of local geometric data, and where  $\tilde{\eta}(\epsilon)$  is the finite dimensional eta invariant or signature for the small eigenvalues of  $\partial_\epsilon$ . If  $\partial_{\bar{M}}$  is invertible, then  $\tilde{\eta}(\epsilon) = 0$  and

$$\lim_{\epsilon \rightarrow 0} \eta(\partial_\epsilon) = \eta_b(\partial_{\bar{M}})$$

Even if  $\partial_{\bar{M}}$  is not invertible, this holds in  $\mathbb{R}/\mathbb{Z}$ . The hypotheses on the Dirac operator on the double cover were later removed in a collaboration of Hassell, Mazzeo, Melrose [13]. Their results were proven by analyzing the resolvent family of  $\partial_\epsilon$  uniformly near zero. This led to a precise description of the behaviour of the small eigenvalues. They also constructed the corresponding heat calculus which contains and describes precisely the heat kernel for  $\partial_\epsilon^2$  uniformly as  $\epsilon \rightarrow 0$ . Our goal here is to obtain precise analytic results like those of [13].

The convergence considered in this paper is more restrictive than that of Cheeger, Colding and Ding, but it is more general than the conic degeneration of McDonald. This convergence will be called *asymptotically conic (ac) convergence*. We note, however, that ac convergence does not require Ricci curvature bounds. The conic collapse of McDonald, the analogous smooth collapse of a higher codimension submanifold and the collapse of an open neighborhood of the manifold with some restrictions on the local geometry all fit this new definition. The author's hope is that this definition and the convergence results proven here for the scalar Laplacian's spectrum and geometric Laplacian's heat kernel will be useful in understanding both manifolds with isolated conic singularities and families of metrics with a singular limit.

## 1.2 Geometric Preliminaries

The definition of *asymptotically conic convergence* involves three geometries: a family of smooth metrics on a compact manifold, a conic metric on a compact manifold, and an *asymptotically conic* or *ac* metric<sup>2</sup>. In this work, we assume the dimension is always greater than or equal to three.

First, we define *ac* metric.

**Definition 1.3** *An ac metric, also known as a scattering metric, is a smooth metric  $g_Z$  on a complete manifold  $Z$  with a product decomposition outside a compact*

---

<sup>2</sup>Note that this definition is sometimes also called "asymptotically locally Euclidean," or *ALE*. However, that term is often used for the more restrictive class of spaces that are asymptotic at infinity to a cone over a quotient of the sphere by a finite group, so to avoid confusion, we use the term *asymptotically conic*.

set  $K$  so that  $Z - K \cong [\rho_0, \infty)_\rho \times Y$ , for some  $\rho_0 > 0$  and as  $\rho \rightarrow \infty$ ,  $g_Z$  has the form

$$g_Z|_{Z-K} = d\rho^2 + \rho^2 h(\rho).$$

Here,  $(Y, h)$  is a smooth, compact,  $n - 1$  manifold with a smooth family of metrics  $\{h(\rho)\}$ , such that as  $\rho \rightarrow \infty$ ,  $h(\rho) \rightarrow h$ , in other words,  $h$  extends to a  $\mathcal{C}^\infty$  tensor on  $(\rho_0, \infty) \times Y$ .

The definition is recast by defining  $r = \frac{1}{\rho}$  and adding a copy of  $(Y, h)$  at the boundary defined by  $r = 0$ . With this compactification of  $Z$  which we call  $\bar{Z}$ , the metric takes the form

$$\frac{dr^2}{r^4} + \frac{h(1/r)}{r^2}$$

on a neighborhood of  $\partial\bar{Z}$  diffeomorphic to  $[0, r_1)_r \times Y$ .

Next, we define a compact Riemannian manifold with isolated conic singularity.

**Definition 1.4** *Let  $M$  be a compact metric space with Riemannian metric  $g$ . Then,  $(M, g)$  has an isolated conic singularity at the point  $p$  if the following hold.*

1.  $(M - \{p\}, g)$  is a smooth, open manifold.
2. There is a neighborhood  $N$  of  $p$  and a function  $x : N - \{p\} \rightarrow (0, x_1]$  for some  $x_1 > 0$ , such that  $N - \{p\}$  is diffeomorphic to  $(0, x_1]_x \times Y$  with metric  $g = dx^2 + x^2 h(x)$  where  $(Y, h)$  is a compact, smooth  $n - 1$  manifold and  $\{h(x)\}$  is a smooth family of metrics on  $Y$  converging to  $h$  as  $x \rightarrow 0$ , in other words,  $h$  extends to a  $\mathcal{C}^\infty$  tensor on  $[0, x_1)_x \times Y$ .

Associated to a manifold with isolated conic singularity is the manifold with boundary obtained by blowing up the cone point, adding a copy of  $(Y, h)$  at this point. Then,  $x$  is a boundary defining function for the boundary,  $(Y, h)$ .

We use  $M_0^0$  to denote the smooth incomplete conic manifold,  $M_c$  to denote the metric space closure of  $M_0^0$ , and  $M_0$  to denote the associated manifold with boundary.

One familiar example of a manifold with isolated conic singularity is  $\mathbb{R}^n$  with the Euclidean metric in polar coordinates,  $dr^2 + r^2 d\theta^2$ , which has a conic singularity

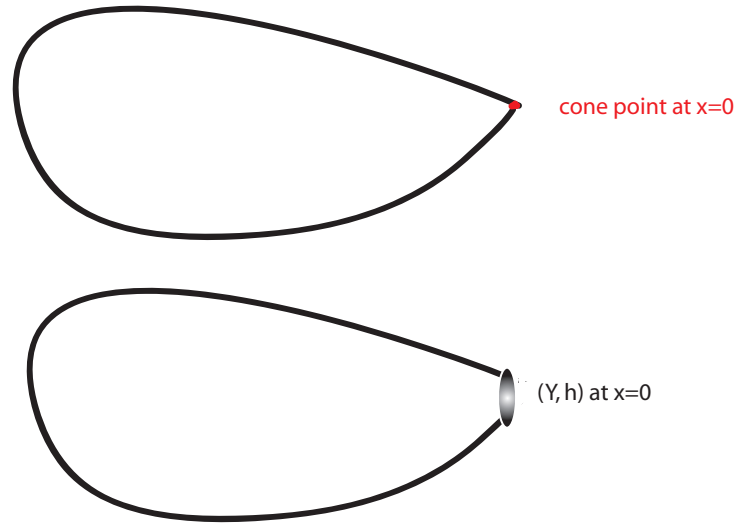

Figure 1.1: Manifold with isolated conic singularity and associated manifold with boundary.

at the origin. In this example the singularity is a feature of the coordinate system, not the underlying manifold. In polar coordinates,  $\mathbb{R}^n$  decomposes as the product  $\mathbb{R}^+ \times \mathbb{S}^{n-1}$  with metric  $dr^2 + r^2 d\theta$ . The metric on the  $\mathbb{S}^{n-1}$  cross sections shrinks as  $r \rightarrow 0$ . A conic singularity generalizes this idea.

The new *resolution blow up* is a nonstandard blow up that resolves an isolated conic singularity in a compact manifold using an asymptotically conic space. In this definition we use the notation  $M \cup_\phi N$  for a smooth manifold constructed from the smooth manifolds  $M$  and  $N$  with a diffeomorphism  $\phi$  from  $V \subset N$  to  $U \subset M$  that gives the equivalence relation,  $V \ni p \sim \phi(p) \in U$ .  $M \cup_\phi N$  is the disjoint union of  $M$  and  $N$  modulo the equivalence relation of  $\phi$ . The smooth structure on  $M \cup_\phi N$  and the topology is induced by that of  $M$  and  $N$ . We now define the new resolution blow up.

**Definition 1.5** *Let  $(M_0, g_0)$  be a compact  $n$  manifold with isolated conic singularity. Let  $(Z, g_z)$  be an asymptotically conic space of dimension  $n$  with compactification  $\bar{Z}$ . Assume the cross sections of  $M_0$  and  $\bar{Z}$  converge at the boundary to*

$(Y, h)$ , a smooth, compact  $n - 1$  manifold. By the definition of conic manifold we decompose  $M_0$  as a union of overlapping open sets,

$$M_0 = K_0 \cup V_0,$$

where  $V_0$  is diffeomorphic to  $(0, r_1)_r \times Y$ . With this diffeomorphism

$$g_0 = dr^2 + r^2 \tilde{h}(r, y) \quad \text{on } (0, r_1) \times Y,$$

where  $\tilde{h}(r, y)$  converges smoothly to  $h$  as  $r \rightarrow 0$ . We identify  $(V_0, g_0)$  with  $((0, r_1)_r \times Y, dr^2 + r^2 \tilde{h}(r, y))$  and assume the boundary of  $K_0$  in  $M_0^0$  is of the form

$$\partial K_0 = \{r = r_1\} \cong Y.$$

Similarly, decompose  $Z$  as a union of overlapping sets,

$$Z = K_z \cup V_z,$$

where  $V_z$  is diffeomorphic to  $(\rho_1, \infty)_\rho \times Y$ . With this diffeomorphism

$$g_z = d\rho^2 + \rho^2 h(\rho, y) \quad \text{on } (\rho_1, \infty) \times Y,$$

with  $h(\rho, y)$  converging smoothly to  $h$  as  $\rho \rightarrow \infty$ . We identify  $(V_z, g_z)$  with  $((\rho_1, \infty)_\rho \times Y, d\rho^2 + \rho^2 h(\rho, y))$  and assume that  $\partial K_z$  is of the form

$$K_z = \{\rho = \rho_1\} \cong Y.$$

Let  $M_{0,\epsilon}$  be the following subset of  $M_0$ ,

$$M_{0,\epsilon} = (\{(r, y) \in V_0 : r > \epsilon\} \cup K_0).$$

Similarly, let  $Z_R \subset Z$  be defined as follows

$$Z_R = (\{(\rho, y) \in V_z : \rho < R\} \cup K_z).$$

The **resolution blow up** of  $(M_0, g_0)$  by  $(Z, g_z)$  is the patched manifold,

$$M_\epsilon = M_{0,\epsilon} \cup_\phi Z_{1/\epsilon},$$

where the patching map  $\phi$  is defined for each  $\epsilon$  by

$$\phi_\epsilon : M_{0,\epsilon} - M_{0,r_1} \rightarrow Z_{1/\epsilon} - Z_{\rho_1}, \quad \phi_\epsilon(r, y) = (r/\epsilon, y).$$

For  $r_1 > \epsilon > \epsilon' > 0$ , the manifolds  $M_\epsilon$  and  $M_{\epsilon'}$  are diffeomorphic, and so the resolution blow up of  $M_0$  by  $Z$  is unique up to diffeomorphism.

We call the resolution blow up a ‘‘patched manifold’’ because a neighborhood of the singularity in  $M_0$  has been replaced by a rescaled patch of the ac space. In the case that  $\bar{Z}$  is a disk, the resolution blow up is a standard radial blow up. The definition of ac convergence uses another new geometric construction related to the resolution blow up, called the asymptotically conic convergence (acc) single space.

**Definition 1.6** Let  $(M_0, g_0)$  be as in the definition of resolution blow up. We may write  $M_0 = V_0 \cup K_0$  with  $V_0 \cong (0, x_1]_x \times Y$  and similarly  $\bar{Z} = V_z \cup K_z$  with  $V_z \cong [0, r_1]_r \times Y$ . Let  $\delta = \min\{x_1, r_1\}$ . Then the asymptotically conic convergence (acc) single space,  $\mathcal{S}$ , is

$$\mathcal{S} = M_0 \times [0, \delta]_\mu \cup_\psi \bar{Z} \times [0, \delta]_\nu,$$

where the joining map  $\psi$  is defined on  $V_0$  by

$$\psi(x, y, \mu) = (\mu, y, x).$$

This induces a smooth structure on  $\mathcal{S}$ . We extend  $x$  on  $M_0$  to be identically equal to  $\delta$  on the complement of the set diffeomorphic to  $(0, \delta]_x \times Y$ , and we similarly extend  $r$  on  $\bar{Z} - [0, \delta]_r \times Y$ . Define  $\epsilon = x\mu = r\nu$  and let  $M_\epsilon = \{\epsilon = \text{constant}\}$ . This is the same as the  $M_\epsilon$  in the definition of resolution blow up.



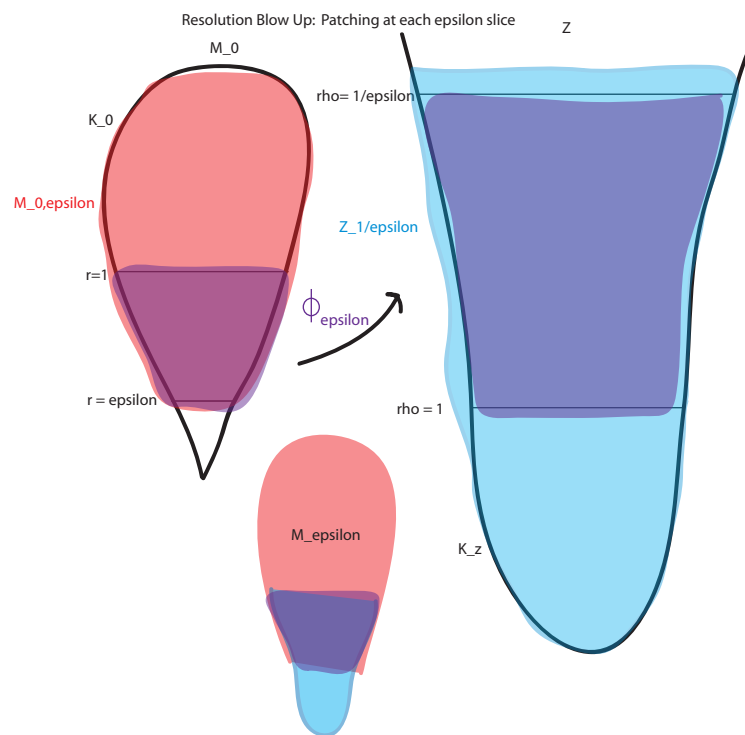

Figure 1.2: Resolution blow up patching.

The acc single space has two hypersurface boundary faces at  $\mu = 0$  and  $\nu = 0$  that we call  $F_0 \cong M_0$  and  $F_1 \cong \bar{Z}$ . These meet in a codimension 2 corner,  $C_1 \cong Y$ . Note that any compact subset of  $M_0^0$  embeds into  $\mathcal{S}$  by  $p \mapsto (p, \epsilon x(p))$ , and similarly, any compact subset of  $\bar{Z}$  embeds into  $\mathcal{S}$  by  $z \mapsto (z, \epsilon r(z))$ .

Now we may define asymptotically conic convergence.

**Definition 1.7** Let  $(M_0, g_0)$ ,  $(Z, g_z)$ ,  $\bar{Z}$  be as above. Let  $\mathcal{S}$  be the associated acc single space. Then the family of metrics  $\{g_\epsilon\}$  converge to  $(M_0, g_0)$ ,  $(Z, g_z)$  asymptotically conically if there is a symmetric 2 cotensor  $\mathcal{G}$  on  $\mathcal{S}$  that restricts to a smooth compact metric  $g_\epsilon$  on each  $M_\epsilon$  slice for  $0 < \epsilon < \delta$  and restricts to  $g_0, g_z$  at  $F_0, F_1$ , respectively. Moreover, we require  $\mathcal{G}$  to be polyhomogeneous at the corner  $C_1$ .

For each  $0 < \epsilon < \delta$ ,  $(M_\epsilon, g_\epsilon)$  is diffeomorphic to the resolution blow up of  $M_0$  by  $Z$  so we may equivalently identify  $\{M_\epsilon\}$  with a family of metrics  $\{g_\epsilon\}$  on a fixed smooth compact manifold,  $M$ . For each  $\epsilon > 0$  the definition gives a diffeomorphism  $\phi_\epsilon$  from  $Z_{1/\epsilon}$  to a fixed open proper subset  $U$  of  $M$  such that  $\frac{1}{\epsilon^2}(\phi_\epsilon)^*g_\epsilon|_U$  converges smoothly to  $g_z$ . Moreover, on  $M - U$ ,  $g_\epsilon$  must converge smoothly to  $g_0$ .

A simple example of asymptotically conic convergence is one nape of an exact cone in  $\mathbb{R}^n$  resolved by a single sheet hyperboloid of revolution. The family of diffeomorphic resolution blow ups are also single sheet hyperboloids. Let  $\mathbb{R}^n = \mathbb{R}^k \times \mathbb{R}^{n-k}$  with coordinates  $x = (y, z)$ . The hyperboloids are defined by

$$|y|^2 - |z|^2 = \epsilon^2, \text{ with } y = (y_1, \dots, y_k) \text{ and } y_1, \dots, y_k > 0.$$

The cone is

$$M_0 = \{(y, z) \in \mathbb{R}^k \times \mathbb{R}^{n-k} : |y|^2 - |z|^2 = 0\}.$$

The ac metric is induced by the Euclidean metric on  $\mathbb{R}^n$ . Let

$$r_y = |y|, r = |z|,$$

and let

$$y = r_y \theta, z = r \omega,$$

where  $\theta \in \mathbb{S}^{k-1}$ ,  $\omega \in \mathbb{S}^{n-k-1}$ . Then on the  $\epsilon$  hyperboloid,

$$r_y^2 = r^2 + \epsilon^2.$$

The Euclidean metric on  $\mathbb{R}^n$  is  $dy^2 + dz^2$ . On  $\mathbb{R}^{n-k}$  away from  $r = 0$  we may express  $dz^2$  in polar coordinates as

$$dz^2 = dr^2 + r^2 h_{n-k}(\omega),$$

where  $h_{n-k}$  is the standard metric on the sphere  $\mathbb{S}^{n-k-1}$ . Similarly, we have

$$dy^2 = dr_y^2 + r_y^2 h_k(\theta)$$

where  $h_k$  is the standard metric on the sphere  $\mathbb{S}^{k-1}$ . Using the relation for  $r_y$  in terms of  $r$  the metric  $g_\epsilon$  is

$$g_\epsilon = \left(1 + \frac{r^2}{r^2 + \epsilon^2}\right) dr^2 + r^2(h_{n-1}(\theta, \omega)) + \epsilon^2 h_{k-1}(\theta).$$

The metric  $g_0$  on the cone is

$$g_0 = 2dr^2 + r^2 h_{n-1}.$$

It is clear that  $(H_1, g_\epsilon)$  are all diffeomorphic for  $\epsilon > 0$ . To verify that  $(H_1, g_\epsilon)$  is a resolution blow up of  $M_0$  by  $H_1$  define  $U \subset H_1$  by  $U = \{r \leq 1\}$ ,  $Z_{1/\epsilon} = \{r \leq 1/\epsilon\}$  and let  $\phi_\epsilon : Z_{1/\epsilon} \rightarrow U$  be defined by

$$\phi_\epsilon(r, \theta, \omega) = (\epsilon r, \theta, \omega).$$

Clearly  $\phi_\epsilon$  is a diffeomorphism from  $H_1 \rightarrow H_1$  and moreover, for coordinates  $(r, \theta, \omega)$  on  $(H_1, g_z)$  with

$$g_z = \left(1 + \frac{r^2}{r^2 + 1}\right) dr^2 + r^2 h_{n-1}(\theta, \omega) + h_{k-1}(\theta),$$

Hyperboloids of Revolution: Example of ac convergence

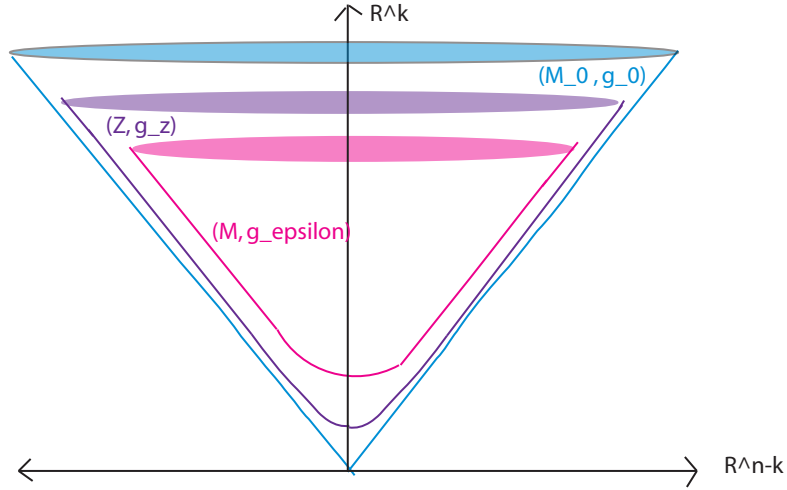

Figure 1.3: Ac convergence example: hyperboloids of revolution

we have for coordinates  $(s, \theta, \omega) = \phi_\epsilon(r, \theta, \omega)$

$$g_\epsilon = \epsilon^2 \left( \left( 1 + \frac{s^2}{s^2 + 1} \right) ds^2 + s^2 h_{n-1}(\omega, \theta) + h_{k-1}(\theta) \right) = \epsilon^2 (\varphi_\epsilon^{-1})^* g_z.$$

Moreover, on  $H_1 - U$  the metrics  $g_\epsilon$  converge smoothly to  $g_0$  and  $(H_1, g_\epsilon)$  is diffeomorphic to the patched manifold  $M_0 - \{r \leq 2\} \cup_\phi H_1$  where for each  $\epsilon$ ,  $\phi$  is defined above.

In this example the acc single space is

$$\mathcal{S} = [((\mathbb{R}^+ \times \mathbb{S}^{n-k-1} \times \mathbb{S}^{k-1}) \times (0, 1]_\epsilon) \cup (\mathbb{R}^+ \times \mathbb{S}^{n-k-1} \times \mathbb{S}^{k-1}); 0].$$

The notation here indicates a standard radial blow up at the origin that creates the codimension 2 corner in the acc single space,  $C_1$  which here is diffeomorphic to  $\mathbb{S}^{n-k-1} \times \mathbb{S}^{k-1}$ .

In the hyperboloid example, the submanifold  $\mathbb{S}^{k-1} \times \mathbb{S}^{n-k-1}$  is collapsing to a cone point, however the definition of ac convergence handles more general collapse.

Acc Single Space: Hyperboloid Example

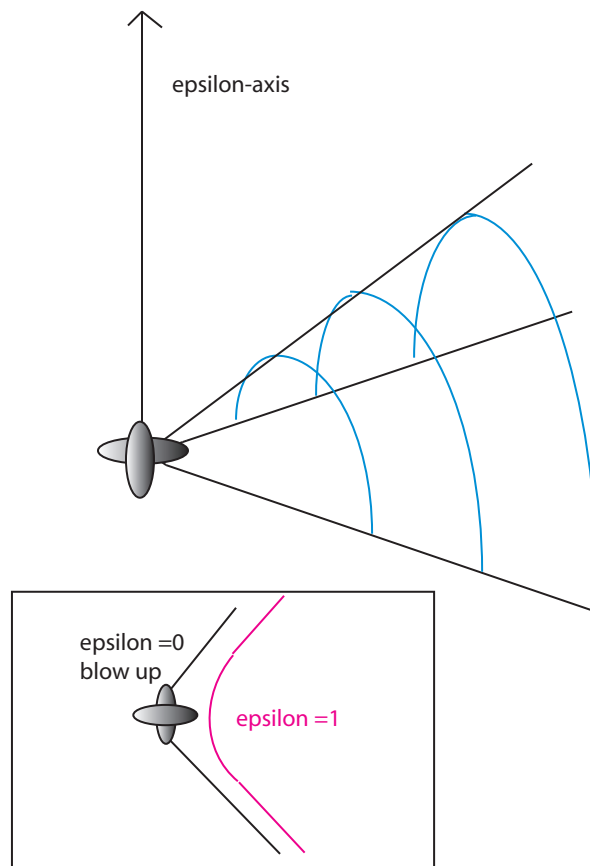

Figure 1.4: Acc single space: hyperboloid example

For example, in algebraic geometry spaces  $\mathbb{C}^n/\Gamma$  where  $\Gamma$  is a finite subgroup of  $SU(n)$  fixing only the origin have a conic singularity at the origin. Blowing up the singularity at the origin results in a smooth ac space,  $Z$ , which is asymptotic to  $\mathbb{C}^n/\Gamma$  at infinity. We may resolve the singular space using the resolution space and construct the acc single space to obtain a family of smooth spaces converging asymptotically conically to the singular limit space.

## 1.8 Analytic Preliminaries

Having described the geometry of ac convergence, we give a brief review of the analysis in this setting.

### Conic Differential Operators and the $b$ -Calculus

Let  $(X_0, g_0)$  be a Riemannian manifold with isolated conic singularity, defined by  $x = 0$ , such that in a neighborhood of the singularity,  $X_0$  has a product decomposition,  $X_0 \cong (0, x_1) \times Y$ , and with this decomposition the metric has the following form

$$g_0 = dx^2 + x^2 h(x).$$

Above,  $\{h(x)\}$  is a smoothly varying family of metrics on  $Y$ , with  $h(x)$  converging smoothly to a fixed smooth metric  $h$ , where  $(Y, h)$  is a smooth,  $n - 1$  dimensional compact manifold. A conic differential operator of order  $m$  is a smooth differential operator on  $X_0$  such that in a neighborhood of the singularity it can be expressed as

$$A = x^{-m} \sum_{k=0}^m B_k(x) (-x\partial_x)^k$$

with  $B_k \in \mathcal{C}^\infty((0, 1), \text{Diff}^{m-k}(Y))$ , where  $\text{Diff}^j(Y)$  denotes the space of differential operators of order  $j \in \mathbb{N}_0$  on  $Y$  with smooth coefficients. The scalar Laplacian is an example of an order 2 conic operator because it is of the form

$$x^{-2} \{(-x\partial_x)^2 + (-n + 1 + xH^{-1}(\partial_x H)(-x\partial_x)) + \Delta_{h(x)}\}$$

where in local coordinates  $(x, y) = (x, y_1, \dots, y_{n-1})$ ,

$$H(x, y) = |\det (h(x)(\partial_{y_i}, \partial_{y_j})|)^{\frac{1}{2}}.$$

We may consider on  $X_0$  the  $b$ -tangent bundle  ${}^bTX_0$  (cf. [24]). For a differential cone operator as above, there is a function  $\sigma_{\psi,b}^m(A) \in \mathcal{C}^\infty({}^bT^*X_0)$  such that in local coordinates near the cone point

$$\sigma_{\psi,b}^m(A)(x, y, \rho, \xi) = x^m \sigma_\psi^m(A)(x, y, \frac{\rho}{x}, \xi),$$

where  $\sigma_\psi^m(A)$  is the usual homogeneous principal symbol of  $A$  on  $X$ .  ${}^bT^*X_0$  denotes the dual of  ${}^bTX_0$  and  $(\rho, \xi) \in \mathbb{R} \times \mathbb{R}^n$  are the covariables to  $(x, y)$ . The cone differential operator is *elliptic* if

$$\sigma_{\psi,b}^m(A) \neq 0 \text{ on } {}^bT^*X_0.$$

The cone differential operators are elements of the cone operator calculus; for a detailed description, see [17]. These cone operators are closely related to  $b$ -operators. First, we define a  $b$ -manifold.

**Definition 1.9** *Let  $(X_b, g_b)$  be a smooth Riemannian manifold with boundary  $(Y, h)$  and boundary defining function  $x$  such that in a collared neighborhood,  $N$ , of the boundary  $X_b$  has a product decomposition  $N \cong [0, x_1)_x \times Y$  and in this neighborhood*

$$g_b = \frac{dx^2}{x^2} + h(x),$$

where  $h(x)$  is a smoothly varying family of metrics on  $Y$  that converges smoothly to  $h$  as  $x \rightarrow 0$ .

Equivalently, a  $b$ -manifold is a complete manifold with asymptotically cylindrical ends. A  $b$ -operator of order  $m$  is a smooth differential operator on  $X_b$  such

that near the boundary of  $X_b$ , it can be expressed as

$$A = \sum_{k=0}^m B_k(x)(-x\partial_x)^k$$

with  $B_k \in \mathcal{C}^\infty((0, 1), \text{Diff}^{m-k}(Y))$ . We see that a cone differential operator of order  $m$  is equal to a rescaled  $b$ -differential operator of order  $m$ . In other words, if  $A$  is an order  $m$  cone differential operator then  $x^m A$  is a  $b$ -differential operator. In terms of the local coordinates near the boundary of  $X_b$ ,  $(x, y_1, \dots, y_{n-1})$ , a  $b$ -operator may be expressed as

$$A = \sum_{j+|\alpha| \leq m} a_{j,\alpha}(x, y)(-x\partial_x)^j(\partial_y^\alpha).$$

Then the  $b$ -symbol of  $A$  can be written as

$${}^b\sigma_m(A) = \sum_{j+|\alpha|=m} a_{j,\alpha}(x, y)\lambda^j\eta^\alpha.$$

Here  $\lambda$  and  $\eta$  are linear functions on  ${}^bT^*X_b$  defined by the coordinates and a generic element of  ${}^bT^*X_b$  is written as

$$\lambda \frac{dx}{x} + \sum_{i=1}^n \eta_i dy_i.$$

The  $b$ -operator is  $b$ -elliptic if the symbol  ${}^b\sigma_m(A) \neq 0$  on  ${}^bT^*X_b - \{0\}$ .

To use the relationship between  $b$ -operators and conic operators, we associate a  $b$ -manifold  $(M_b, g_b)$  to the conic manifold  $(M_0, g_0)$ . In a collared neighborhood of the boundary of the form  $U = \{0 < x < 1\}$ ,  $g_b$  has the form  $\frac{dx^2}{x^2} + h(x)$ . Using a smooth cutoff function, we may extend  $g_b$  to agree with  $g_0$  on  $M_b - U$ . The Schwartz kernels of  $b$ -differential operators are naturally defined on the  $b$ -double space. Recall, the  $b$ -double space is defined to be  $M_b \times M_b$  radially blown up along the submanifold  $\partial M_b \times \partial M_b = Y \times Y$  and is written  $[M_b \times M_b; \partial M_b \times \partial M_b]$ . For a complete description of the  $b$ -calculus and the  $b$ -double space, see [24].

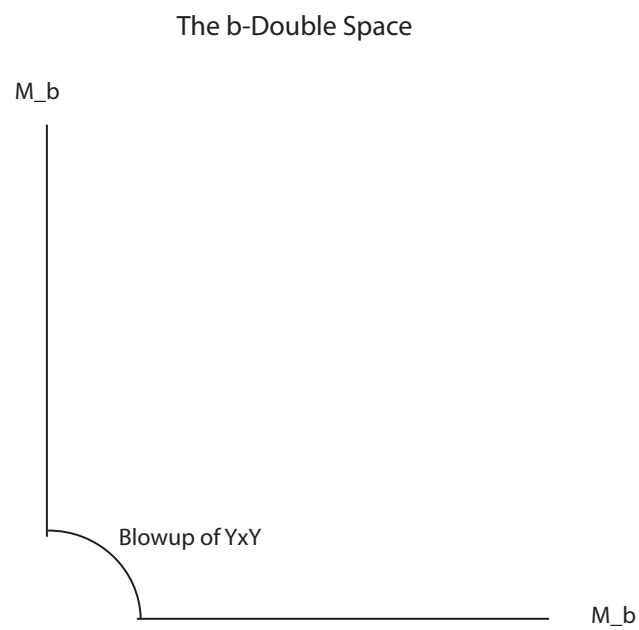

Figure 1.5: The  $b$ -double space

The Laplacian on  $M_0$ ,  $\Delta_0$ , is equal to

$$x^{-2}\{(-x\partial_x)^2 + (-n + 1 + xH^{-1}(\partial_x H)(-x\partial_x)) + \Delta_{h(x)}\} = x^{-2}L_b$$

where  $L_b$  is an elliptic order 2  $b$ -operator. The Schwartz kernel of  $L_b$  is a distribution on the  $b$ -double space. By the  $b$ -calculus theory, (see [24])  $L_b$  has a parametrix  $G_b$ , such that  $G_b$  is a  $b$ -operator with

$$G_b L_b = I - R$$

where  $I$  is the identity operator and  $R$  is a  $b$ -operator with polyhomogeneous Schwartz kernel on the  $b$ -double space. Then, for any  $u \in \mathcal{L}^2(x^{n-1}dx dy)$  with  $\Delta_0 u = f \in \mathcal{L}^2(x^{n-1}dx dy)$

$$(x^2 G_b)(x^{-2} L_b u) = (x^2 G_b)f = u - Ru \quad \implies \quad u = x^2 G_b f + Ru = \alpha + \beta.$$

The first term,  $\alpha \in x^2 H_b^2 \subset x^2 \mathcal{L}^2(x^{n-1}dx dy)$ . Then  $u \in \mathcal{L}^2(x^{n-1}dx dy)$  implies  $\beta \in \mathcal{L}^2(x^{n-1}dx dy)$  and has a polyhomogeneous expansion as  $x \rightarrow 0$ ,

$$\beta \sim \sum_{j=0}^{\infty} \sum_{k=0}^{N_j} x^{\gamma_j+k} \varphi_j(y).$$

Above  $\gamma_j$  is an indicial root for the operator  $L_b$  and  $\varphi_j$  is an eigenfunction on  $(Y, h)$ . Then,

$$u = \alpha + \sum_{j=0}^{\infty} \sum_{k=0}^{N_j} x^{\gamma_j+k} \varphi_j(y) \tag{1.1}$$

where  $\alpha \in x^2 \mathcal{L}^2(x^{n-1}dx dy)$ .

### The Domain of the Laplacian on manifolds with isolated conic singularity.

The Laplacian  $\Delta_0$  for the conic manifold  $(M_0, g_0)$  is an unbounded operator on  $\mathcal{L}^2(M_0)$ . It can be extended to various domains in  $\mathcal{L}^2$ . The smallest domain

considered is denoted  $\mathcal{D}_{\min}$  and is obtained by taking the  $\mathcal{C}_0^\infty$  closure of the graph of  $\Delta_0$  in  $\mathcal{L}^2$ .

**Definition 1.10** *The minimal domain of  $\Delta_0$ , denoted  $\mathcal{D}_{\min}$  is defined to be:*

$$\mathcal{D}_{\min} = \{u \in \mathcal{L}^2(M_0) : \exists u_j \in \mathcal{C}_0^\infty(M_0), u_j \rightarrow u, \Delta_0 u_j \rightarrow f\}. \quad (1.2)$$

*The convergence here is in  $\mathcal{L}^2$  and  $\Delta_0 u$  is defined to be  $f$ . We denote by  $\Delta_{\min}$  the Laplacian on  $\mathcal{D}_{\min}$ .*

The largest domain considered is called  $\mathcal{D}_{\max}$  and is obtained by taking the  $\mathcal{L}^2$  closure of the graph of  $\Delta_0$  in  $\mathcal{L}^2$ .

**Definition 1.11** *The maximal domain of  $\Delta_0$ , is defined to be:*

$$\mathcal{D}_{\max} = \{u \in \mathcal{L}^2(M_0) : \Delta u \in \mathcal{L}^2(M_0)\}. \quad (1.3)$$

*We denote by  $\Delta_{\max}$  the Laplacian on  $\mathcal{D}_{\max}$ .*

Both of the preceding domains are dense in  $\mathcal{L}^2(M_0)$ , and with either extension the Laplacian is a closed operator. On complete manifolds these domains would be equal by the Gaffney-Stokes Theorem [9]. However,  $M_0$  is incomplete and so in general these domains will not be equal. We choose a domain that lies between these, namely the Friedrich's domain, and work with the Friedrich's extension of the Laplacian. The Friedrich's domain,  $\mathcal{D}_F$ , is the closure of the graph of  $\Delta_0$  in  $\mathcal{L}^2$  with respect to the densely defined Hermitian form,

$$Q(u, v) = \int_{M_0} \nabla u \nabla v \, dV_0.$$

This extension preserves the lower bound of the operator, so for the scalar Laplacian, the Friedrich's extension is positive and essentially self adjoint.

For elements of  $\mathcal{D}_{max}$ , with  $u \in \mathcal{L}^2$  and  $\Delta_0 u = f \in \mathcal{L}^2$ , we have the expansion (1.1) from the preceding section,

$$u = \alpha + \sum_{j=0}^{\infty} \sum_{k=0}^{N_j} x^{\gamma_j+k} \varphi_j(y).$$

The volume form on  $M_0$  near the conic tip is asymptotic to  $x^{n-1} dx dy$ . Therefore, the exponents  $\gamma_j$  must all be strictly greater than  $-\frac{n}{2}$ . For  $v \in \mathcal{D}_{min} \subset \mathcal{D}_{max}$  the above decomposition and the definition of  $\mathcal{D}_{min}$  imply that  $\mathcal{D}_{min} \subset x^2 \mathcal{L}^2$ . The equality of  $\mathcal{D}_{min}$  and  $\mathcal{D}_{max}$  then depends on the indicial roots of  $L_b = x^2 \Delta_0$ . For further discussion of domains of the conic Laplacian, see [11], whose results include:

$$\mathcal{D}_F = \{f \in \mathcal{L}^2 : \Delta_0 f \in \mathcal{L}^2 \text{ and } f = \mathcal{O}(x^{\frac{2-n+\delta}{2}}) \text{ as } x \rightarrow 0, \text{ for some } \delta > 0\}.$$

We will use this characterization of the domain of the (Friedrich's extension of the) Laplacian in the proof of the theorem.

## 1.12 Spectral Convergence

First we define the spectral convergence that will be proven here. Let  $\Delta_\epsilon$  be the Laplacian for  $(M, g_\epsilon)$ ,  $\Delta_0$  be the (Friedrich's extension of the) Laplacian on the conic metric  $(M_0, g_0)$ , and let  $\sigma(\Delta)$  be the spectrum of  $\Delta$ .

**Definition 1.13**  $\sigma(\Delta_\epsilon)$  converges to  $\sigma(\Delta_0)$  if the set of accumulation points of  $\{\sigma(\Delta_\epsilon)\}$  at  $\epsilon = 0$  is  $\sigma(\Delta_0)$ , with correct multiplicities.

We now have all the ingredients for the preliminary result.

**Theorem 1.14** Let  $\{g_\epsilon\}$  be a family of smooth metrics on a compact Riemannian  $n$ -manifold,  $M$ , with  $n \geq 3$ . Let  $(M_0, g_0)$  be a compact Riemannian  $n$ -manifold with isolated conic singularity and let  $(Z, g_z)$  be an ac space. Assume  $(M, g_\epsilon)$  converges asymptotically conically to  $(M_0, g_0), (Z, g_z)$ . Let  $\Delta_\epsilon$  be the scalar Laplacian on  $(M, g_\epsilon)$  and let  $\Delta_0$  be the Friedrich's extension of the scalar Laplacian on  $(M_0, g_0)$ . Then  $\sigma(\Delta_\epsilon) \rightarrow \sigma(\Delta_0)$ .

The proof requires three steps: the inclusion *accumulation*  $\sigma(\Delta_\epsilon) \subset \sigma(\Delta_0)$ , the reverse inclusion *accumulation*  $\sigma(\Delta_\epsilon) \supset \sigma(\Delta_0)$ , and correct multiplicities.

## 1.15 Proof Step 1: Accumulation $\sigma(\Delta_\epsilon) \subset \sigma(\Delta_0)$

To prove this inclusion, we extract a smoothly convergent sequence of eigenfunctions corresponding to a converging sequence of eigenvalues as  $\epsilon \rightarrow 0$ . We then show that the limit function of this sequence is an eigenfunction for the conic metric and its eigenvalue is the accumulation point. For this argument, we work with sequences of metrics  $\{g_{\epsilon_j}\}$  which we abbreviate  $\{g_j\}$  with Laplacians  $\Delta_j$ .

Let  $\lambda(\epsilon_j)$  be an eigenvalue of  $\Delta_j$ , with eigenfunction  $f_j$ . Assume that  $\lambda(\epsilon_j) \rightarrow \bar{\lambda}$ . Over any compact set  $K \subset M_0^0$ , the metric  $g_j = g_{\epsilon_j}$  converges smoothly to  $g_0$ , thus so do the coefficients of  $\Delta_j - \lambda(\epsilon_j)$ . Hence, normalizing  $f_j$  by  $\sup_M |f_j| = 1$ , it follows using standard elliptic estimates and the Arzela-Ascoli theorem that  $f_j$  converges in  $\mathcal{C}^\infty$  on any compact subset of  $M_0^0$ . Furthermore the limit function  $\bar{f}$  satisfies the limiting equation

$$\Delta_0 \bar{f} = \bar{\lambda} \bar{f}.$$

However, we do not know yet that  $\bar{f} \not\equiv 0$ , nor, even if this limit is nontrivial, that it lies in the domain of the Friedrichs extension of  $\Delta_0$ . This is the content of the arguments below.

### Weight Functions

Using the diffeomorphisms  $\phi_\epsilon$ , we pull back the radial function  $\rho$  on  $Z$  to  $U - K$ , rescale by  $\epsilon$  and then extend to the rest of  $M$ . Explicitly,

$$w_\epsilon = \begin{cases} 1 & \text{on } M - U. \\ \epsilon (\phi_\epsilon^{-1})^* \rho & \text{on } U - K. \\ \epsilon & \text{on } K. \end{cases}$$

We write  $w_j$  for  $w_{\epsilon_j}$ . For some  $\delta > 0$  to be chosen later, replace  $f_j$  by  $\frac{f_j}{\|w_j^\delta f_j\|_\infty}$ . We may then assume the supremum of  $|f_j w_j^\delta|$  is 1 on  $M$ . As  $M$  is compact,  $|f_j|$

attains a maximum at some point  $p_j \in M$ , and we may assume  $p_j$  converges to some  $\bar{p} \in M$ . The argument splits into three cases depending on how and where  $p_j$  accumulates in  $M$ .

### 1.15.1 Case 1: $w_j(p_j) \rightarrow c > 0$ as $j \rightarrow \infty$ .

In this case, the points  $\{p_j\}$  are accumulating in a compact subset of  $M_0^0$  at some point  $\bar{p} \neq p$  (the cone point). The maximum of  $|f_j w_j^\delta|$  on  $M$  is 1 and occurs at  $p_j$ .

$$|f_j| \leq w_j^{-\delta} \text{ on } M \text{ for each } j \implies |f_j(p_j)| \rightarrow c^{-\delta} \text{ as } j \rightarrow \infty.$$

The locally uniform  $\mathcal{C}^\infty$  convergence of  $f_j$  to  $\bar{f}$  implies that  $|\bar{f}|$  satisfies a similar bound,

$$|\bar{f}| \leq x^{-\delta} \text{ on } M_0,$$

and clearly  $|\bar{f}(\bar{p})| = c^{-\delta} \neq 0$ . By the assumption that the dimension of  $M$  and  $M_0$  is greater than or equal to three and the characterization of the Friedrich's Domain of the Laplacian, we may choose  $\delta$  so that

$$\frac{2-n}{2} < -\delta < 0.$$

Then  $\bar{f}$  blows up slower than  $x^{\frac{2-n}{2}}$  as  $x \rightarrow 0$ , and so  $\bar{f}$  lies in the Friedrich's domain of the Laplacian. It satisfies the equation,

$$\Delta_0 \bar{f} = \bar{\lambda} \bar{f},$$

so  $\bar{\lambda}$  is an eigenvalue of  $\Delta_0$  and the proof of the first step is complete in this case.

### 1.15.2 Case 2: $w_j(p_j) = \mathcal{O}(\epsilon_j)$ as $j \rightarrow \infty$ .

This case leads to a contradiction using the acc space,  $Z$ . Let  $\phi_j = \phi_{\epsilon_j}$  according to the definition of the acc single space. Let  $\tilde{f}_j = \phi_j^* f_j$  and  $\tilde{w}_j = \phi_j^* w_j$ . Then  $\tilde{w}_j = \epsilon_j \rho$ , where  $\rho$  is the radial variable on  $Z$ . Define  $\rho$  globally on  $Z$  by extending it to be identically 1 on the complement of the set  $\{\rho \geq \rho_0\}$  in  $Z$ . Let  $\tilde{p}_j = \phi_j(p_j)$ .

Because  $|f_j w_j^\delta|$  attains its maximum value of 1 at  $p_j$ ,  $|\tilde{f}_j(p_j)| = \epsilon_j^{-\delta}$ . Rescale  $f_j$  and  $\tilde{f}_j$ , replacing them respectively with  $\epsilon_j^\delta f_j$  and  $\epsilon_j^\delta \tilde{f}_j$  so that the maximum of  $|\tilde{f}_j \rho^\delta|$  occurs at the point  $\tilde{p}_j \in Z_j$  and is equal to 1. Since  $w_j(p_j) = \mathcal{O}(\epsilon_j)$ ,  $\rho(\tilde{p}_j) = \epsilon_j^{-1} w_j(p_j)$  stays bounded for all  $j$ , and so we assume  $\tilde{p}_j$  converges to  $\tilde{p} \in Z$ . By the definition of ac convergence,  $(Z_j, \epsilon_j^{-2} \phi_j^* g_j|_U)$  converges smoothly to  $(Z_j, g_Z)$ . This implies the following equation is satisfied by  $\tilde{f}_j$  on  $Z_j$ ,

$$\Delta_Z \tilde{f}_j = \epsilon_j^2 \lambda(\epsilon_j) \tilde{f}_j + O(\epsilon_j).$$

Since the  $\lambda(\epsilon_j)$  are converging to  $\bar{\lambda}$  and  $|\tilde{f}_j \rho^\delta| \leq 1$  on  $Z_j$ , we have

$$\Delta_Z \tilde{f}_j \rightarrow 0 \text{ as } j \rightarrow \infty \text{ on any compact subset of } Z.$$

This implies  $f_j \rightarrow \bar{f}$  on  $M$  and correspondingly,  $\tilde{f}_j \rightarrow \tilde{f}$ , locally uniformly  $\mathcal{C}^\infty$  on  $Z$  and  $\tilde{f}$  satisfies the equation,

$$\Delta_Z \tilde{f} = 0.$$

Moreover,  $|\tilde{f} \rho^\delta| \leq 1$  with equality at the point  $\tilde{p}$ . This implies  $\tilde{f}$  is not identically zero and decays like  $\rho^{-\delta}$  as  $\rho \rightarrow \infty$ . There are no such harmonic functions on  $Z$ , which leads to a contradiction.

### 1.15.3 Case 3: $\frac{\epsilon_j}{w_j(p_j)} \rightarrow 0$ as $j \rightarrow \infty$ .

This case also leads to a contradiction. The analysis is on the complete cone over  $(Y, h)$ . Consider the coordinates  $(\rho, y)$ , defined for  $\rho \geq 1$ . In these coordinates the metric on  $Z$  has the form  $d\rho^2 + \rho^2 h(\rho)$ . Let  $r_j = w_j(p_j) \rho$ . Consider the family of metrics  $\{\tilde{g}_j\}$  on  $Z_j$  defined by

$$\tilde{g}_j = w_j(p_j)^2 g_Z.$$

On  $Z_j$  where  $\rho$  is defined,  $\tilde{g}_j$  takes the form

$$dr_j^2 + r_j^2 h(r_j w_j(p_j)^{-1}) \text{ for } r_j \in (\rho_0 w_j(p_j), w_j(p_j)^{-1}).$$

Then, as  $j \rightarrow \infty$ , the metric  $h(r_j w_j(p_j)^{-1})$  converges smoothly to  $h$ , and the metric  $\tilde{g}_j$  converges to

$$g_C = dr^2 + r^2 h$$

on the exact cone over  $(Y, h)$ , which we call  $C$ . Let  $\tilde{f}_j = w_j(p_j)^\delta (\phi_j)^* f_j$ . Since  $|f_j w_j^\delta| \leq 1$  with equality at  $p_j$ ,

$$|\tilde{f}_j r_j^\delta| \leq 1 \text{ on } (Z_j, \tilde{g}_j) \text{ with equality at } \tilde{p}_j = w_j(p_j)^\delta \phi_j^{-1}(p_j).$$

Moreover, the Laplacian,  $\tilde{\Delta}_j$  on  $Z_j$  with respect to the metric  $\tilde{g}_j$ , satisfies

$$\tilde{\Delta}_j = w_j(p_j)^{-2} \Delta_Z,$$

so

$$\tilde{\Delta}_j \tilde{f}_j = \frac{\epsilon_j^2}{w_j(p_j)^2} \lambda(\epsilon_j) \tilde{f}_j + O(\epsilon_j) \text{ on } (Z_j, \tilde{g}_j).$$

In this case,  $\frac{\epsilon_j^2}{w_j(p_j)^2} \lambda(\epsilon_j) \tilde{f}_j + O(\epsilon_j)$  goes to 0 as  $j \rightarrow \infty$ , and so we have a locally uniform  $C^\infty$  limit of  $\{\tilde{f}_j\}$ ,  $f_C$  defined on  $C$  satisfying

$$|f_C r^\delta| \leq 1 \text{ on } C,$$

$$\Delta_C f_C = 0 \text{ on } C.$$

Since the points  $\tilde{p}_j$  stay at a bounded radial distance with respect to the radial variable  $r_j$  on  $Z_j$ , we may assume  $\tilde{p}_j \rightarrow p_C$  for some  $p_C \in C$ . At this point,  $|f_C(p_C) r(p_C)^\delta| = 1$  so  $f_C$  is not identically zero. By separation of variables (see, for example, [20]),  $f_C$  has an expansion in an orthonormal eigenbasis of  $\mathcal{L}^2(Y, h)$ ,

$$f_C = \sum_{j \geq 0} a_{j,+} r^{\gamma_{j,+}} \phi_j(y) + a_{j,-} r^{\gamma_{j,-}} \phi_j(y)$$

where  $\gamma_{j,+/-}$  are indicial roots corresponding to  $\phi_j$  and  $a_{j,+/-} \in \mathbb{C}$ . In order for  $|f_C r^\delta| \leq 1$  globally on  $C$ , we must have only one term in this expansion,  $f_C = a_j r^{-\delta} \phi_j(y)$ . Because the indicial roots are discrete, we may choose  $\delta$  so that



$-\delta$  is not an indicial root. This is a contradiction and completes Step One.

## 1.16 Proof Step 2: $\sigma(\Delta_0) \subset \text{Accumulation } \sigma(\Delta_\epsilon)$

Here we show the reverse inclusion of Step 1. We use the Rayleigh-Ritz characterization of the eigenvalues. Let  $\lambda_l(\epsilon_j)$  be the  $l^{\text{th}}$  eigenvalue of  $\Delta_j$ . Let

$$R_j(f) := \frac{\langle \nabla f, \nabla f \rangle_j}{\langle f, f \rangle_j}.$$

The subscript  $j$  denotes that the inner product is taken with respect to the  $\mathcal{L}^2$  norm on  $M$  with the  $g_j$  metric. The eigenvalues are characterized using Mini-Max by

$$\lambda_l(\epsilon_j) = \inf_{\dim L = l, L \subset C^1(M)} \sup_{f \in L} R_j(f).$$

Similarly this characterization holds for the eigenvalues of the (Friedrich's extension of the) conic Laplacian which are known to be discrete (see [3], for example). Because  $\mathcal{C}_0^\infty(M_0)$  is dense in  $\mathcal{L}^2(M_0)$  we may restrict to subspaces contained in  $\mathcal{C}_0^\infty(M_0)$ . Then, the  $l^{\text{th}}$  eigenvalue of  $\Delta_0$  is

$$\bar{\lambda}_l = \inf_{\dim L = l, L \subset \mathcal{C}_0^\infty(M_0)} \sup_{f \in L} R_0(f)$$

Let  $\bar{\lambda}_l$  be the  $l^{\text{th}}$  eigenvalue in the spectrum of  $\Delta_0$ . Fix  $\epsilon > 0$ . Then there exists  $L \subset \mathcal{C}_0^\infty$  with  $\dim(L) = l$  and

$$\sup_{f \in L} R_0(f) < \bar{\lambda}_l + \epsilon.$$

Since any  $f \in L$  is also in  $\mathcal{C}_0^\infty(M)$  and because  $L$  is finite dimensional, by the convergence of  $g_j$  to  $g_0$ , for large  $j$  we have

$$|R_j(f) - R_0(f)| < \epsilon \text{ for any } f \in L.$$

Since  $\lambda_l(\epsilon_j)$  is the infimum we have

$$\lambda_l(\epsilon_j) \leq \bar{\lambda}_l + 2\epsilon.$$

This implies that  $\{\lambda_l(\epsilon_j)\}$  is bounded in  $j$  and so we extract a convergent subsequence. Then from Step One, for each  $l$

$$\lambda_l(\epsilon_j) \rightarrow \mu_l \leq \bar{\lambda}_l$$

$$f_{j,l} \rightarrow u_l, \quad \Delta_0 u_l = \mu_l u_l.$$

We now show that these limit eigenfunctions  $u_l$  are orthogonal to one another. Fix  $l, k$ , with  $f_{j,k} \rightarrow u_k$  and  $f_{j,l} \rightarrow u_l$ . Since  $\mathcal{C}_0^\infty(M_0)$  is dense in  $\mathcal{L}^2(M_0)$  we may choose a smooth cutoff function  $\chi$  vanishing identically near the conic tip of  $M_0$  such that

$$\begin{aligned} \|\chi u_k - u_k\|_{L^2(M_0)} &< \epsilon, \\ \|\chi u_l - u_l\|_{L^2(M_0)} &< \epsilon, \\ \text{Vol}_j(M - \text{support}(\chi)) &< \epsilon. \end{aligned}$$

Then on the support of  $\chi$ ,  $g_j \rightarrow g_0$  uniformly and so for large  $j$ ,

$$\begin{aligned} |\langle u_k, u_l \rangle_0 - \langle \chi u_k, \chi u_l \rangle_0| &< \epsilon, \\ |\langle \chi u_k, \chi u_l \rangle_0 - \langle \chi u_k, \chi u_l \rangle_j| &< \epsilon, \\ |\langle \chi u_k, \chi u_l \rangle_j - \langle \chi u_k, \chi f_{j,l} \rangle_j| &< \epsilon, \\ |\langle \chi u_k, \chi f_{j,l} \rangle_j - \langle \chi f_{j,k}, \chi f_{j,l} \rangle_j| &< \epsilon. \end{aligned}$$

Finally for large  $j$ , because the eigenfunctions for  $\Delta_j$  were chosen to be orthonormal and the volume of  $M - \text{support}(\chi)$  is small with respect to  $g_j$ ,

$$|\langle \chi f_{j,k}, \chi f_{j,l} \rangle_j| < 2\epsilon.$$

This shows that  $\langle u_k, u_l \rangle_0$  can be made arbitrarily small and so these eigenfunctions are orthogonal. We then complete this basis to form an eigenbasis of  $\mathcal{L}^2(M_0)$ . Let  $\bar{f}_l$  be an arbitrary element of this eigenbasis, with eigenvalue  $\bar{\lambda}_l$ . We wish to show that this  $\bar{f}_l$  is actually the  $u_l$  above, defined to be the limit of (a subsequence of)  $\{f_{j,l}\}$ , and hence the corresponding  $\mu_l$  is equal to  $\bar{\lambda}_l$ . Again, assume the smooth cut-off function  $\chi$  is chosen so that

$$\|\chi\bar{f}_l - \bar{f}_l\|_{L^2(M_0)} < \epsilon.$$

For each  $j$  we expand  $\chi\bar{f}_l$  in eigenfunctions of  $\Delta_j$ ,

$$\chi\bar{f}_l = \sum_{k=0}^{\infty} a_{j,k} f_{j,k}, \quad \text{where } a_{j,k} = \langle \chi\bar{f}_l, f_{j,k} \rangle_j.$$

Now, fix  $k$  and choose  $\chi$  such that

$$\|\chi u_k - u_k\|_{L^2(M_0)} < \epsilon.$$

Then,

$$|\langle \chi\bar{f}_l, f_{j,k} \rangle_0 - \langle \chi\bar{f}_l, f_{j,k} \rangle_j| < \epsilon,$$

$$|\langle \chi\bar{f}_l, f_{j,k} \rangle_j - \langle \chi\bar{f}_l, u_k \rangle_j| < \epsilon,$$

$$|\langle \chi\bar{f}_l, u_k \rangle_j - \langle \chi\bar{f}_l, u_k \rangle_0| < \epsilon,$$

$$|\langle \chi\bar{f}_l, u_k \rangle_0 - \langle \bar{f}_l, u_k \rangle_0| < \epsilon.$$

We have shown above  $\langle \bar{f}_l, u_k \rangle_0 = 0$  if  $\bar{f}_l \neq u_k$ , and otherwise is 1. This implies that for each  $k$ ,  $a_{j,k} \rightarrow 0$  since  $j \rightarrow \infty$  for all  $k$  with  $u_k \neq \bar{f}_l$ . Because  $f_l$  is not identically zero there must be some  $k$  with  $u_k = \bar{f}_l$ . This shows that *every* eigenfunction of  $\Delta_0$  is the limit of (a subsequence of)  $\{f_{j,k}\}$  and the corresponding eigenvalue  $\bar{\lambda}_k$  is the corresponding limit of eigenvalues. This completes Step Two of the proof.

### 1.17 Proof Step 3: Correct Multiplicities

Let  $\lambda$  be an eigenvalue for  $\Delta_0$  with  $k$  dimensional eigenspace spanned by  $u_1, \dots, u_k$ . First, we show that the multiplicity of  $\lambda$  as an accumulation point is at least  $k$ . Assume the multiplicity is  $k-1$ . The Rayleigh-Ritz characterization of the eigenvalues in Step Two shows that  $u_1, \dots, u_{k-1}$  are limits of (subsequences of)  $f_{j,1}, \dots, f_{j,k-1}$ . Moreover, as shown in Step Two, the limit of  $f_{j,k}, \bar{f}_k$  has eigenvalue  $\bar{\lambda} \leq \lambda$ . Since the limit of  $f_{j,k-1}, u_{k-1}$  has eigenvalue  $\lambda$ ,  $\lambda \leq \bar{\lambda}$ . Therefore,  $\bar{\lambda} = \lambda$  and the limit of  $f_{j,k}, \bar{f}$  is orthogonal to  $\{u_1, \dots, u_{k-1}\}$ , which implies that the multiplicity of  $\lambda$  as an accumulation point is at least  $k$ , the dimension of its eigenspace.

Conversely, we show that the multiplicity of an accumulation point cannot be larger than the dimension of the eigenspace. Assume the multiplicity is  $k+1$ . Then,  $f_{j,1}, \dots, f_{j,k+1}$  converges to  $u_1, \dots, u_{k+1}$ , all with eigenvalue  $\lambda$ . However, as we showed in Step Two, these limit eigenfunctions are all orthogonal, which implies that the dimension of the eigenspace of  $\lambda$  must be at least  $k+1$ . Hence, the multiplicity of  $\lambda$  as an accumulation point is at most the dimension of its eigenspace.

Altogether this shows that the eigenvalues of  $\Delta_0$  are achieved with the correct multiplicities as accumulation points of  $\{\sigma(\Delta(\epsilon))\}$  as  $\epsilon \rightarrow 0$ . This completes the proof of the theorem.

♡

# Chapter 2

## Heat Kernels

For each of the geometries of asymptotically conic convergence we construct the heat space and on this space define a heat operator calculus that contains the heat kernel. We describe the asymptotic behavior of each of these heat kernels on the corresponding heat space. These constructions are key ingredients in the proof of the main result in chapter three.

### 2.1 Heat Kernel for a Smooth, Compact Manifold

While a summary for the case of a smooth, compact manifold is provided here, the full details are in [24]. Let  $(M, g)$  be a smooth, compact Riemannian manifold with Hermitian vector bundle  $(E, \nabla)$ . Let  $\Delta$  be a geometric Laplacian<sup>1</sup> associated to  $(M, g, E, \nabla)$ . The associated heat operator is

$$\partial_t + \Delta.$$

---

<sup>1</sup>A *geometric Laplacian* is an operator of the form  $\nabla^* \nabla + R$  such that  $R$  is a self adjoint endomorphism of  $E$ . Note that the square of the Dirac operator is a geometric Laplacian as is the Hodge Laplacian on  $k$ -forms, by the Bochner Theorem (cf. [26]).

The Schwartz kernel  $H$  for the solution operator is called the heat kernel. It is a tempered distributional section of  $M \times M \times \mathbb{R}^+$  that satisfies

$$(\partial_t + \Delta)H(z, z', t) = 0, \quad t > 0,$$

$$H(z, z', 0) = \delta(z - z'),$$

where  $(z, z')$  are coordinates on  $M \times M$  and  $t$  is the time variable on  $\mathbb{R}^+$ . The heat operator is self-adjoint and consequently has symmetry in the space variables

$$H(z, z', t) = H(z', z, t)^*.$$

A parametrix for the heat operator on a smooth compact manifold is constructed from the Euclidean heat kernel (cf. [26]). Recall the Euclidean heat kernel

$$G(z, z', t) = (4\pi t)^{-\frac{n}{2}} \exp\left(-\frac{|z - z'|^2}{2t}\right).$$

This kernel is smooth away from the diagonal  $\{z = z'\}$  at  $t = 0$ . Similarly, the heat kernel for  $(M, g)$  is smooth on  $M \times M \times \mathbb{R}^+$  away from the diagonal at  $t = 0$ .

### 2.1.1 The Heat Space for a Smooth, Compact Manifold

The heat space,  $M_h^2$ , is a manifold with boundary obtained from  $M \times M \times \mathbb{R}^+ = M_+^2$  by performing a  $t$ -parabolic blow up along the submanifold,

$$S_{d2} = \{z = z', t = 0\}.$$

The resulting face,  $F_{d2}$  is the inward pointing  $t$ -parabolic normal bundle of  $S_{d2}$  with defining function  $\rho_{d2}$ . The subscript indicates that  $F_{d2}$  is the diagonal blow up at which the scalar variable  $t$  vanishes to order 2. There is another boundary face at  $t = 0$ ,  $F_1$  with defining function  $\rho_1$ . When the coordinate  $t$  on  $M \times M \times \mathbb{R}^+$  is lifted to the interior of  $M_h^2$ , it is no longer a defining function for  $F_1$ . Let  $\beta^* : M_+^2 \rightarrow M_h^2$

be the blow-up map and  $\beta_* : M_h^2 \rightarrow M_+^2$  be the blow-down map. Then,

$$\beta^*(t) = \rho_1(\rho_{d,2})^2.$$

The  $F_1$  face is diffeomorphic to  $M \times M - \Delta$  where  $\Delta$  is the diagonal in  $M \times M$ .

### 2.1.2 The Smooth, Compact Heat Calculus

We construct the heat kernel using a heat operator calculus. One may also construct the heat kernel locally as in [26]. The heat calculus consists of the Schwartz kernels of operators which lift to the heat space,  $M_h^2$ , to have polyhomogeneous expansions up to each boundary face. For normalization purposes, we define calculus elements using half densities. Each element is the product of a distributional section and a half density on  $M_+^2$ . We fix a half density on  $M_+^2$ , for example,  $\mu = |dzdz'dt|^{\frac{1}{2}}$ , where  $dz$  and  $dz'$  represent the smooth measure induced by  $g$  on each copy of  $M$ . Any other smooth half density on  $M_+^2$  differs from this one by conjugation with a smooth nonvanishing function. Due to the use of half densities, the definition of the heat calculus includes certain normalizing factors to facilitate the composition rule.

**Definition 2.2** *The  $k^{\text{th}}$  order heat calculus on a smooth, compact manifold,  $(M, g)$ , written  $\Psi_H^k$  consists of distributional section half densities of  $M_+^2$  that lift to  $M_h^2$  to satisfy three properties. Let  $A$  be such a distribution section half density of  $M_+^2$ . Then,  $A \in \Psi_H^k$  if the following hold.*

1. *The lift of  $A$  to  $M_h^2$  is smooth on the interior of  $M_h^2$ .*
2.  *$A$  vanishes to infinite order at  $F_1$ .*
3.  *$A \in (\rho_{d2})^{-\frac{1}{2}(n+3)-k} \mathcal{C}^\infty(F_{d2})$ .*

The action of an element  $A \in \Psi_H^k$  on a smooth section half density  $f$  is

$$Af(z, t) = \int_M \langle A(z, z', t), f(z') \rangle dz'.$$

We require elements of  $\Psi_H^k$  to act as convolution in the time variable, so for a smooth section of  $M \times \mathbb{R}^+$ ,

$$Af(z, t) = \int_0^t \int_M \langle A(z, z', t-s)f(z', s) \rangle dz' ds.$$

Two elements of the heat calculus compose as follows.

**Theorem 2.3** *Let  $A$  be an element of  $\Psi_H^{k_1}$  and  $B$  be an element of  $\Psi_H^{k_2}$ . Then, the composition  $A \circ B$  is an element of  $\Psi_H^{k_1+k_2}$ .*

For the proof of this composition rule, see [24]. Since the heat operator  $\partial_t + \Delta$  is of order 2 we expect the heat kernel to be an element of  $\Psi_H^{-2}$ . To construct the heat kernel, take the lift of the Euclidean heat kernel as a first approximation. Call this  $H_1$ . Applying the heat operator to  $H_1$  one has

$$(\partial_t + \Delta)H_1 = K_1,$$

where  $K_1$  vanishes to one order higher on the boundary faces of  $M_h^2$ . Let  $H_2 = H_1 - H_1 \circ K_1$ .  $H_2$  satisfies

$$(\partial_t + \Delta)H_2 = K_2,$$

where the error term  $K_2$  vanishes to yet one order higher on the  $M_h^2$  boundary faces. This process is repeated to obtain  $H_\infty$  satisfying

$$(\partial_t + \Delta)H_\infty = K_\infty,$$

where  $K_\infty \in \Psi_H^\infty$ ;  $K_\infty$  vanishes to infinite order on the boundary faces of  $M_h^2$ . This is achieved using Borel summation to construct a sum whose asymptotic expansion is  $H_1, H_2, H_3, \dots$ . For details on this construction, see [28].

Formally, it is known that a tempered distribution satisfying

$$(\partial_t + \Delta)H(z, z', t) = 0, \quad t > 0,$$

$$H(z, z', 0) = \delta(z - z'),$$



exists. We call this  $H$ . By construction,  $H_\infty$  satisfies the same initial condition,

$$H_\infty(z, z', 0) = \delta(z - z').$$

The difference,  $H_\infty - H = K$  then satisfies

$$K|_{t=0} = 0,$$

$(\partial_t + \Delta)K$  vanishes to infinite order on all boundary faces of  $M_h^2$ .

By parabolic regularity  $K \in \Psi_H^\infty$ , consequently,  $H_\infty + K \in \Psi_H^{-2}$  with the above asymptotic expansion and moreover,  $H_\infty + K = H$ .

## 2.4 $b$ -Heat Kernel

The geometries of ac convergence are closely related to the  $b$ -geometry of [24]. Consequently, the operators studied in ac convergence are closely related to  $b$ -operators. Here is a brief summary of the geometry of  $b$ -manifolds and the  $b$ -heat kernel.

### 2.4.1 $b$ -Geometry and $b$ -Operators

A  $b$ -manifold  $(M, g)$  is a complete manifold with asymptotically cylindrical ends. It is compactified as a manifold with boundary having a product decomposition near the boundary such that, if  $x$  is a boundary defining function,

$$g = \frac{dx^2}{x^2} + h(x).$$

Above,  $\{Y, h(x)\}$  is a smoothly varying family of metrics on  $Y$ , a compact  $n - 1$  manifold and  $h(x)$  converge to  $(Y, h)$  as  $x \rightarrow 0$ ; equivalently,  $h$  extends to a symmetric 2 cotensor on  $[0, x_1)_x \times Y$  for some  $x_1 > 0$ . In a neighborhood of the

boundary define the  $b$ -vector fields,

$$\mathcal{V}_b = \{x\partial_x, \partial_y\},$$

which form a basis for the  $b$ -tangent bundle,  ${}^bT M$ . The co-vectors,

$$\left\{\frac{dx}{x}, dy\right\},$$

form a basis for the  $b$ -cotangent bundle,  ${}^bT^* M$ .

A  $b$ -operator,  $L$ , on  $(M, g)$  is a partial differential operator on the interior of  $M$  that can be expressed using the  $b$ -vector fields in a neighborhood of  $\partial M$  as,

$$L = \sum_{j+|\alpha|\leq m} a_{j,\alpha}(x)(x\partial_x)^j(\partial_y)^\alpha$$

where  $\alpha$  is a multi-index and  $a_{j,\alpha}(x) \in \mathcal{C}^\infty([0, x_1])$  for some  $x_1 > 0$ . A  $b$ -operator is *b-elliptic* if it is elliptic in the usual sense on the interior of  $M$  and is an elliptic combination of the  $b$ -vector fields in a neighborhood of the boundary of  $M$ . An example of an elliptic  $b$ -operator is a geometric Laplacian,  $\Delta$ , associated to a Hermitian vector bundle  $(E, \nabla)$  over  $(M, g)$  such that  $E$  retracts onto a Hermitian bundle  $(E_y, \nabla_y)$  over  $(Y, h)$ . Such a geometric Laplacian is of the form

$$\Delta = (x\partial_x)^2 + \Delta_y + lot$$

where  $\Delta_y$  is the induced Laplacian on  $(Y, h)$  and  $lot$  are lower order terms. A conic geometric Laplacian,  $\Delta_0$ , is a re-scaled  $b$ -Laplacian,

$$\Delta_0 = (\partial_x)^2 + x^{-2}(\Delta_y + lot)$$

where  $x = 0$  defines the singularity and  $Y$  is the cross section. Factoring out the  $x^{-2}$ ,

$$\Delta_0 = x^{-2}((x\partial_x)^2 + \Delta_y + lot) = x^{-2}\Delta_b,$$

where  $\Delta_b$  is a  $b$ -geometric Laplacian. Similarly, we may express an asymptotically

conic geometric Laplacian as a re-scaled  $b$ -Laplacian. Let  $x = 0$  define the boundary,  $(Y, h)$ , of the compactified ac space,  $\bar{Z}$ . Then, a geometric Laplacian on  $\bar{Z}$ ,  $\Delta_z$ , near  $\partial\bar{Z}$  has the form

$$\Delta_z = x^4 \partial_x^2 + x^2(\Delta_y + lot) = x^2((x\partial_x)^2 + \Delta_y + lot) = x^2 \Delta_b$$

where  $\Delta_b$  is a  $b$ -geometric Laplacian.

## 2.4.2 The $b$ -Heat Kernel

We construct the  $b$ -heat kernel by first constructing the  $b$ -heat space, then defining the  $b$ -heat calculus, and finally using a first approximate model operator together with the composition rule of the calculus to produce the  $b$ -heat kernel.

### The $b$ -heat space

The  $b$ -heat space is a manifold with corners constructed from  $M \times M \times \mathbb{R}^+$ . First we take  $M \times M$  and blow up radially at  $\partial M \times \partial M$ . This is the  $b$ -double space,

$$M_b^2 = [M \times M; \partial M \times \partial M],$$

see also figure 1.5.

We now include the time variable and blow up  $t$ -parabolically the diagonal in  $M \times M$  at  $t = 0$ . The resulting manifold with corners is the  $b$ -heat space,

$$M_{b,h}^2 = [M_b^2 \times \mathbb{R}_t^+; \Delta(M \times M) \times \{t = 0\}]_{t\text{-parabolic}},$$

where  $\Delta(M \times M)$  is the diagonal.

The  $b$ -heat space has five boundary faces as follows.<sup>2</sup>

---

<sup>2</sup>The subscript notation used throughout indicates the order to which each of the scalar variables vanish at that face. For example, at  $F_{110}$  the first two scalar variables,  $x$  and  $x'$ , vanish to first order while the third scalar variable,  $t$  does not vanish (vanishes to 0 order).

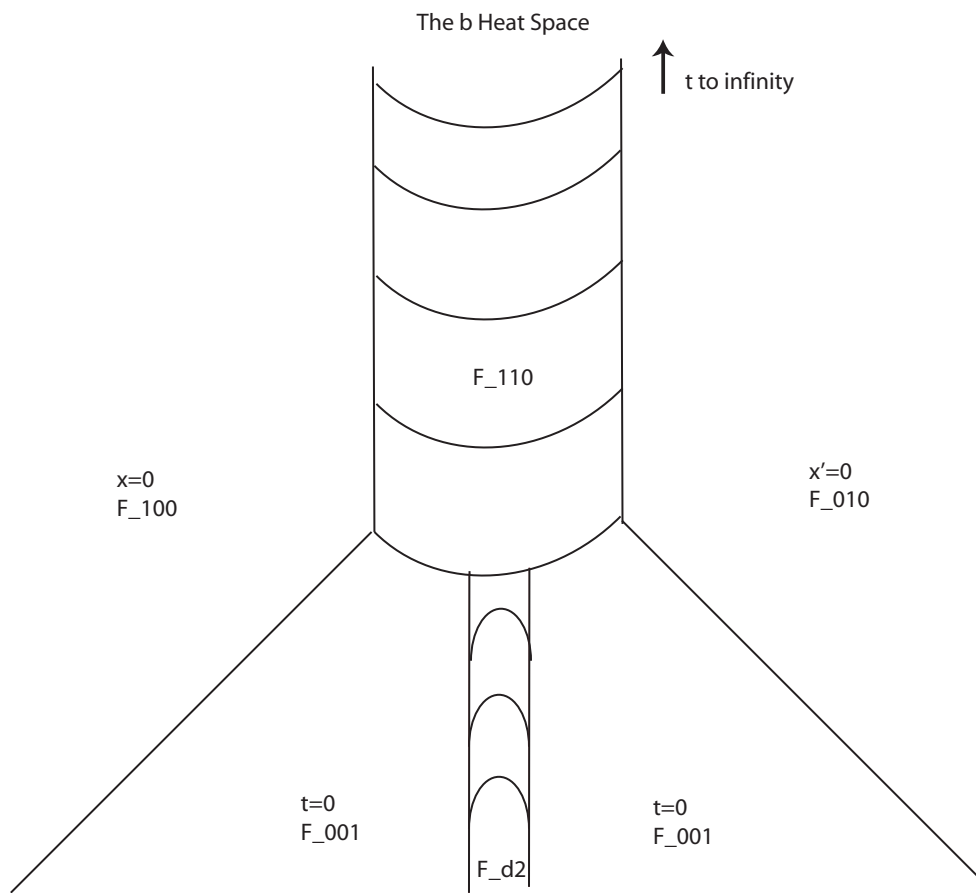

Figure 2.1: The  $b$ -heat space.

Face	Blow up of/locally defined by	Defining Function
$F_{110}$	$S_{110} = \{x = 0, x' = 0\}$	$\rho_{110}$
$F_{d2}$	$S_{d2} = \{z = z', t = 0\}$	$\rho_{d2}$
$F_{100}$	$\{x = 0\} - F_{110}$	$\rho_{100}$
$F_{010}$	$\{x' = 0\} - F_{110}$	$\rho_{010}$
$F_{001}$	$\{t = 0\} - F_{d2}$	$\rho_{001}$

The  $b$ -heat calculus consists of distributional section half density kernels on the  $b$ -heat space,  $M_{b,h}^2$ .

**Definition 2.5** For any  $k \in \mathbb{R}$  and index set  $E_{110}$ ,  $A$  is an element of the  $b$ -heat calculus,  $\Psi_{b,H}^{E_{110},k}$ , if the following hold.

1.  $A \in \mathcal{A}_{phg}^{-\frac{1}{2}+E_{110}}(F_{110})$ .
2.  $A$  vanishes to infinite order at  $F_{001}$ ,  $F_{100}$ , and  $F_{010}$ .
3.  $A \in \rho_{d2}^{-\frac{n+3}{2}-k} \mathcal{C}^\infty(F_{d2})$ .

Because the heat calculus is defined with half densities, the normalizing factors at  $F_{110}$  and  $F_{d2}$  simplify the composition rule.

**Theorem 2.6** Let  $A \in \Psi_{b,H}^{k_a, \mathcal{A}}$  and let  $B \in \Psi_{b,H}^{k_b, \mathcal{B}}$ . Then the composition,  $A \circ B$  is an element of  $\Psi_{b,H}^{k_a+k_b, \mathcal{A}+\mathcal{B}}$ .

### The $b$ -heat kernel asymptotics on the $b$ -heat space

The construction of the  $b$ -heat kernel is similar to the construction of the smooth compact heat kernel. The  $b$ -heat kernel behaves like the Euclidean heat kernel on the interior of  $M_h^2$  and near  $F_{d2}$ . To determine an appropriate model kernel at  $F_{110}$ , the heat operator  $\partial_t + \Delta_b$  is lifted to the  $b$ -heat space and restricted to  $F_{110}$ . This restriction is called the *normal operator* of  $\partial_t + \Delta_b$ . The model kernel at  $F_{110}$  is the kernel of a first order parametrix of this normal operator and is smooth at this face. At  $F_{100}$ ,  $F_{010}$ , and  $F_{001}$  the model kernel vanishes to infinite order. The approximations at each face are smoothly extended to the interior. As in the smooth case, the composition rule is used to solve away the error and

the model kernel determines the asymptotic behavior of the  $b$ -heat kernel on  $M_{b,h}^2$ . This behavior is summarized here and concludes our study of the  $b$ -heat kernel.

Face	Leading order
$F_{110}$	0; as $t \rightarrow \infty$ , decays like $t^{-\frac{1}{2}}$
$F_{d2}$	$-\frac{n+3}{2} - (-2)$
$F_{100}$	$\infty$
$F_{010}$	$\infty$
$F_{001}$	$\infty$

## 2.7 The Conic Heat Kernel

Let  $(M_0, g_0)$  be a compact manifold with isolated conic singularity and let  $(E_0, \nabla_0)$  be a Hermitian vector bundle over  $(M_0, g_0)$ . Let  $\Delta_0$  be the Friedrich's extension of a geometric Laplacian on  $(M_0, g_0)$ . Associated to  $\Delta_0$  is the heat operator  $\partial_t + \Delta_0$  and the corresponding heat kernel which we call the conic heat kernel. The conic heat kernel is smooth on the interior of  $M_0 \times M_0 \times \mathbb{R}^+ = M_+^2$  by parabolic regularity (cf. [28]); away from the conic singularity it behaves like the heat kernel for a smooth, compact manifold. Near the conic singularity, however, the behavior of this heat kernel is more subtle.

### 2.7.1 The Conic Heat Space

This construction comes from [25]. The conic heat space is a manifold with corners obtained from  $M_0 \times M_0 \times \mathbb{R}^+ = M_+^2$  by blowing up along two submanifolds. In a neighborhood of the conic singularity,  $M_0$  has a product structure with coordinates  $z = (x, y)$  where  $x \in (0, x_1]$  and  $y = (y^1, \dots, y^{n-1})$  are coordinates on  $(Y, h)$ . In terms of the local coordinates  $(z, z', t) = (x, y, x', y', t)$  on  $M_+^2$  the two submanifolds are

$$S_{112} \{x = 0, x' = 0, t = 0\},$$

$$S_{d2} = \{(z, z, 0) : z \in M_0^0\}.$$

$S_{112}$  is the codimension 3 corner at  $t = 0$  at the intersection of the singularity in each copy of  $M_0$ .  $S_{d2}$  is the singular set for the initial data, the diagonal of  $M_0 \times M_0$  at time  $t = 0$ . These submanifolds are blown up parabolically in the direction of the conormal bundle,  $dt$ , replacing each submanifold by its inward pointing  $t$ -parabolic normal bundle. The boundary faces created by these blow ups are  $F_{112}$  and  $F_{d2}$ , respectively. The resulting manifold with corners is the *conic heat space* and denoted  $M_{0,h}^2$ .

In the local coordinates,  $(x, y, x', y', t, )$ , the defining function for  $F_{112}$  is

$$\rho_{112} = (x^4 + (x')^4 + t^2)^{\frac{1}{4}}.$$

In a neighborhood of this face, we have coordinates  $(\theta, \theta', r, y, y', \tau)$ , where  $x = r\theta$ ,  $x' = r\theta'$ , and  $t = r^2\tau$ . We do not actually need the  $\theta'$  coordinate because  $\theta, \theta', \tau$  satisfy

$$\theta^4 + (\theta')^4 + \tau^2 = 1.$$

The second blown up face,  $F_{d2}$ , has defining function

$$\rho_{d2} = (|z - z'|^4 + t^2)^{\frac{1}{4}}.$$

There are three additional boundary faces in the conic heat space,

$$F_{100} = \{x = 0\} - F_{112},$$

$$F_{010} = \{x' = 0\} - F_{112},$$

$$F_{001} = \{t = 0\} - (F_{112} \cup F_{d2}).$$

The defining functions for these faces are respectively  $\rho_{100}$ ,  $\rho_{010}$ ,  $\rho_{001}$ . Using standard blow-up notation the conic heat space is

$$M_{0,h}^2 = [M_0 \times M_0 \times \mathbb{R}^+; S_{112}; S_{d2}]_{t\text{-parabolic}}.$$

The blow up construction of  $M_{0,h}^2$  from  $M_+^2$  induces blow up and blow down

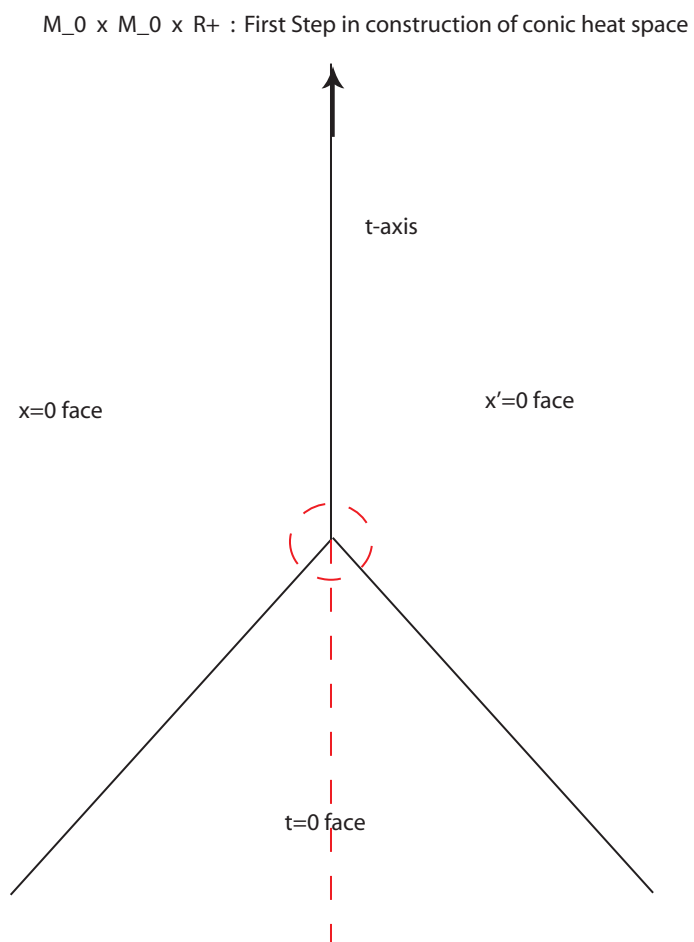

Figure 2.2: Construction of the conic heat space:  $M_+^2$ .



maps,  $\beta^* : M_+^2 \rightarrow M_{0,h}^2$  and  $\beta_* : M_{0,h}^2 \rightarrow M_+^2$ , which are isomorphisms on the interiors of these spaces. The coordinates  $(x, x', t)$  lift via  $\beta^*$  to

$$(\beta^*)(x) = \rho_{100}\rho_{112},$$

$$(\beta^*)(x') = \rho_{010}\rho_{112},$$

$$(\beta^*)(t) = \rho_{001}(\rho_{112})^2.$$

The boundary faces of  $M_{0,h}^2$  are defined in terms of  $\beta^*$  by

$$F_{100} = cl\{\beta^*((Y \times M_0 \times [0, \infty)_t) - S_{112})\},$$

$$F_{010} = cl\{\beta^*((M_0 \times Y \times [0, \infty)_t) - S_{112})\},$$

$$F_{0,0,1} = cl\{\beta^*(S_{112} - S_{d2})\},$$

$$F_{d2} = cl\{\beta^*(S_{d2})\},$$

$$F_{112} = cl\{\beta^*((M_0 \times M_0 \times \{0\}) - S_{d2})\}.$$

In the above  $cl\{\cdot\}$  denotes the closure in  $M_{0,h}^2$ .

### 2.7.2 Conic Heat Kernel First Approximation

We construct the conic heat kernel by building its Taylor expansion at each boundary face of  $M_{0,h}^2$ . First, an approximate solution to the heat equation at each face is chosen so that the error term vanishes to some positive order. We then use the heat calculus to iterate this process, constructing a parametrix with error term vanishing to infinite order at the  $F_{112}$ ,  $F_{d2}$ , and  $F_{001}$  boundary faces of  $M_{0,h}^2$ . Finally, Duhamel's Principle is used to construct the full heat kernel from this parametrix.

Away from the conic singularity the Euclidean heat kernel is a good first approximation, so this is our first approximation on the interior of  $M_{0,h}^2$  and at the  $F_{d2}$  and  $F_{001}$  faces. Near the  $F_{100}$ ,  $F_{010}$  and  $F_{112}$  faces, however, this is not a good first approximation. Instead, we take the heat kernel for the exact cone over  $(Y, h)$  and transplant it to  $F_{112}$ . This kernel is then extended to the  $F_{100}$  and  $F_{010}$  faces.

Convenient local coordinates on  $F_{112}$  are the projective coordinates,  $(s, s', y, y', \tau)$

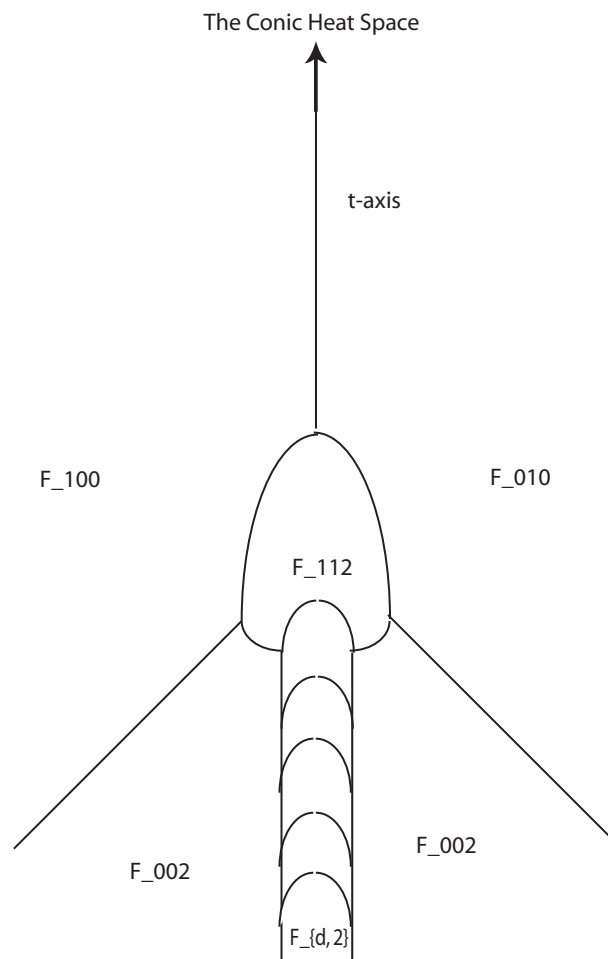

Figure 2.3: The conic heat space,  $M_{0,h}^2$ .

with  $s = \frac{x}{x'}$ ,  $s' = x'$ , and  $\tau = \frac{t}{(x')^2}$ . These are valid away from  $F_{010}$ . Since we are using the Friedrich's extension of  $\Delta_0$  the heat kernel satisfies  $H(z, z', t) = H(z', z, t)^*$ . This symmetry allows us to study the heat kernel using these projective coordinates because the leading orders at  $F_{010}$  and  $F_{100}$  are the same. In projective coordinates, the variable  $s'$  is a defining function for  $F_{112}$  and the heat kernel becomes

$$\partial_t + \Delta_0 = (s')^{-2}(\partial_\tau + \Delta_{0,s}) + E. \quad (2.1)$$

Here,  $\Delta_{0,s}$  is a geometric Laplacian for the exact cone over  $(Y, h)$  and  $E$  is an error term with leading order  $(s')^{-1}$  at  $F_{112}$ . We express the heat kernel as an expansion near  $F_{112}$  as follows

$$H(z, z', t) \sim \sum_{j \geq 0} (s')^{\alpha_j} h_j(s, s', y, y', \tau)$$

where the exponents  $\alpha_j \in \mathbb{C}$  depend on the eigenvalues of the induced geometric Laplacian on the cross section  $(Y, h)$ . The heat kernel  $H$  must satisfy

$$(\partial_t + \Delta_0)H = 0, \quad t > 0.$$

In the projective coordinates this becomes

$$(s')^{-2}(\partial_\tau + \Delta_{0,s})H + EH = 0, \quad t > 0.$$

Applying the heat operator to the Taylor expansion of  $H$  gives

$$\sum_{j \geq 0} (s')^{\alpha_j - 2} (\partial_\tau + \Delta_{0,s})h_j(s, s', y, y', \tau) + (s')^{\alpha_j} E h_j(s, s', y, y', \tau) = 0.$$

The first term gives the equation

$$(s')^{\alpha_0 - 2} (\partial_\tau + \Delta_0)h_0(s, s', y, y', \tau) = 0.$$

Therefore,  $h_0$  should be some power of  $(s')$  times the heat kernel  $H_0$  for  $\partial_\tau + \Delta_{0,s}$ ,

$$h_0 = (x')^\beta H_0.$$

Recall the initial conditions that  $H$  must satisfy

$$H(x, x', y, y', 0) = \delta(x - x')\delta(y - y') = (s')^{-1}\delta(s - 1)\delta(y - y').$$

The heat kernel for the exact cone,  $H_0$ , satisfies

$$H_0(s, 1, y, y', 0) = \delta(s - 1)\delta(y - y').$$

So the first term in the expansion of  $H$  should be

$$(s')^{-1}H_0(s, 1, y, y', \tau).$$

This shows that the leading order term of  $H$  at  $F_{112}$  is

$$H_1(x, y, x', y', t) = (\rho_{112})^{-1}H_0(s, 1, y, y', \tau),$$

where  $H_0$  is the heat kernel for the exact cone over  $(Y, h)$ .

### The Heat Kernel on the Exact Cone

Let  $(X, g_x)$  be the exact cone over  $(Y, h)$  with coordinates  $(x, y)$  and metric

$$g_x = dx^2 + x^2h.$$

For the existence and construction of the heat kernel for  $(X, g_x)$  we refer to [20]. The heat kernel  $H_0$  for  $(X, g_x)$  has a polyhomogeneous conormal expansion on  $X_h^2$  with leading orders at  $F_{100}$ ,  $F_{010}$  and  $F_{112}$  given by a complicated expression involving the eigenvalues of the induced geometric Laplacian on  $(Y, h)$ , the rank of the bundle, and the dimension of  $X$ . For a detailed description of this dependence see [2].

A direct calculation on the exact cone gives the homogeneity property for  $H_0$ ,

$$H_0(cx, cx', y, y', c^2t) = c^n H_0(x, x', y, y', t).$$

The homogeneity of  $H_0$  and symmetry in  $x, x'$  imply

$$H_1(x, y, x', y', t) = (\rho_{112})^{-1}(\rho_{100}\rho_{010})^{-n} H_0(x, x', y, y', t).$$

The following table shows the leading orders of  $H_1$  on the boundary faces of  $M_{0,h}^2$ .

Boundary Face of $M_{0,h}^2$	Leading order
$F_{112}$	$-1 + \nu_0$
$F_{100}$	$-n + \mu_0$
$F_{010}$	$-n + \mu_0$
$F_{d2}$	$-n$
$F_{001}$	$\infty$

Above,  $\nu_0$  and  $\mu_0$  are the leading terms in the polyhomogeneous conormal expansion of  $H_0$  at  $F_{112}$  and  $F_{100}$ , respectively. The following is a brief review of polyhomogeneity.

### Polyhomogeneous Expansions

On manifolds with boundary having a product structure near the boundary, a natural class of functions (or sections) with good regularity near the boundary are the polyhomogeneous conormal functions (or sections). For a more complete reference on polyhomogeneity, see [21]. In a neighborhood of the boundary of  $M_0$ , or equivalently, in a neighborhood of the conic singularity of  $M_0$ , we have coordinates  $(x, y)$  with the metric  $g_0$  expressed in these coordinates as

$$g_0 = dx^2 + x^2h(x).$$

The  $b$ -tangent bundle,  $\mathcal{V}_b$ , in a neighborhood of the singularity, is spanned by the vector fields,

$$\{x\partial_x, \partial_y^\alpha\}.$$

The basic conormal space of sections is

$$\mathcal{A}^0(M_0) = \{\phi : V_1 \dots V_l \phi \in L^\infty(M_0), \forall V_i \in \mathcal{V}_b, \text{ and } \forall l\}.$$

Let  $\alpha$  and  $p$  be multi indices with  $\alpha_j \in \mathbb{C}$  and  $p_j \in \mathbb{N}_0$ . Then we define

$$\mathcal{A}^{\alpha,p}(M_0) = x^\alpha (\log x)^p \mathcal{A}^0.$$

The space  $\mathcal{A}^*$  is the union of all these spaces, for all  $\alpha$  and  $p$ . The space  $\mathcal{A}_{phg}^*(M_0)$  consists of all conormal distributional sections which have an expansion of the form

$$\phi \sim \sum_{Re(\alpha_j) \rightarrow \infty} \sum_{p=0}^{p_j} x^{\alpha_j} (\log x)^p a_{j,p}(x, y), \quad a_{j,p} \in \mathcal{C}^\infty.$$

We define an index set to be a discrete subset  $E \subset \mathbb{C} \times \mathbb{N}_0$  such that

$$(\alpha_j, p_j) \in E, |(\alpha_j, p_j)| \rightarrow \infty \implies Re(\alpha_j) \rightarrow \infty.$$

Then, the space  $\mathcal{A}_{phg}^E(M_0)$  consists of those distributional sections  $\phi \in \mathcal{A}_{phg}^*$  having polyhomogeneous expansions with  $(\alpha_j, p_j) \in E$ .

### 2.7.3 The Conic Heat Calculus

The construction of the conic heat calculus is originally due to [25]. This calculus gives a rule for composing kernels that are smooth on the interior of  $M_{0,h}^2$  with specified regularity, vanishing, or polyhomogeneous expansions at each boundary face.

The heat calculus is defined using half densities. Let  $\mu$  be a conic half density on  $M_0 \times M_0 \times \mathbb{R}^+$ . We may assume

$$\mu = (xx')^{\frac{n-1}{2}} \sqrt{dzdz'dt} = \sqrt{dV_c dt}.$$

Any other choice of conic half density on  $M_0 \times M_0 \times \mathbb{R}^+$  is obtained from  $\mu$  by conjugation with a nonvanishing smooth function. We also fix a smooth, nonvanishing

half density,  $\nu$ , on  $M_{0,h}^2$ .

**Definition 2.8** *Let  $k \in \mathbb{R}$  and  $E_{100}$   $E_{010}$   $E_{112}$  be index sets. A distributional section half density,  $A$ , of  $M_+^2$  is an element of the heat calculus  $\Psi_{0,H}^{k,E_{100},E_{010},E_{112}}$  if its lift to  $M_{0,h}^2$ , which we also call  $A$ , has the following behavior at the five boundary faces of  $M_{0,h}^2$ .*

1.  $A \in \mathcal{A}_{phg}^{E_{100}}(F_{100})$ .
2.  $A \in \mathcal{A}_{phg}^{E_{010}}(F_{010})$ .
3.  $A \in \mathcal{A}_{phg}^{E_{112}}(F_{112})$ .
4.  $A$  vanishes to infinite order at  $F_{001}$ .
5.  $A \in \rho_{d2}^{-\frac{n+3}{2}-k} \mathcal{C}^\infty(F_{d2})$ .

With this normalization the conic heat kernel has order  $k = -2$  and the composition rule works out nicely. To prove the composition rule we must first construct the conic triple heat space,  $M_{0,h}^3$ .

### The Conic Triple Heat Space

The conic triple heat space,  $M_{0,h}^3$ , is a manifold with corners obtained by performing a series of blow ups on  $M_0 \times M_0 \times M_0 \times \mathbb{R}^+ \times \mathbb{R}^+$ . To each copy of  $M_0$  we associate a copy of the Hermitian vector bundle,  $(E, \nabla)$ . We refer to the three copies of  $M_0$  as  $M_0$ ,  $M'_0$ , and  $M''_0$  and the corresponding three copies of  $E$  as  $E$ ,  $E'$ , and  $E''$ . Given two kernels,  $A$  and  $B$ , of the conic heat calculus,  $A$  induces an operator taking sections of  $E$  to sections of  $E' \times \mathbb{R}^+$ , while  $B$  takes sections of  $E' \times \mathbb{R}^+$  to sections of  $E'' \times \mathbb{R}^+$ . For example, if  $f$  is a smooth half density section of  $M$ , then  $A$  acts on  $f$  by

$$A(f)(z, t) = \int_{M_0} \langle (\beta_* A)(z, z', t), f(z') \rangle dz'$$

where  $\beta_*$  is the blow down map from  $M_{0,h}^2$  to  $M_+^2$ . These kernels act in another way, by convolution in the  $t$  variable,

$$A(f)(z, t) = \int_{M_0} \int_0^t \langle (\beta)_* A(z, z', s), f(z', t - s) \rangle ds dz'.$$

Because of the special action of elements of the heat calculus on the time variable as convolution operators, the triple heat space construction involves only 2 copies of  $\mathbb{R}^+$ .

Formally, the composition of two elements of the conic heat calculus is obtained by lifting both elements to the triple heat space, taking their product and pushing forward to the heat space. It is then necessary for the triple heat space to have partial blow-down/projection maps to three identical copies of  $M_{0,h}^2$  and full blow-down maps to three identical copies of  $M_+^2$ . The three copies of  $M_{0,h}^2$  and  $M_+^2$  will be called the left, right and center and the blow up or down maps corresponding to each are  $\beta_L, \beta_R, \beta_c$ . An upper  $*$  denotes the lift to the triple heat space and the lower  $*$  denotes the push forward to the heat space. In other words,  $(\beta_R)^*$  is the lift of the right heat space to the triple heat space. In the composition of  $A$  and  $B$ , the kernel  $A$  is lifted from the left copy of  $M_{0,h}^2$  to the triple heat space while the kernel  $B$  is lifted from the right copy of  $M_{0,h}^2$  where their product is taken and pushed forward to the center copy of  $M_{0,h}^2$ . We would like the maps,  $\beta_L, \beta_R, \beta_c$  to preserve polyhomogeneity so that the lifted product of  $A$  and  $B$  on the triple heat space pushed forward under  $(\beta_C)_*$  is again an element of the conic heat calculus with expansions determined by those of  $A$  and  $B$ . Such maps on manifolds with corners which preserve polyhomogeneity are called *b-fibrations*.

### **b-Maps and b-Fibrations**

For a complete reference, see [21]. The maps  $\beta_{L,R,C}$  from  $M_{0,h}^3$  to the three copies of  $M_{0,h}^2$  must be a special kind of map, known as a *b-fibration*, in order to preserve polyhomogeneity and prove the composition rule for the conic heat calculus. The first definition is a more general class of maps, of which a *b-fibration* is one specific type.



**Definition 2.9** Let  $M_1$  be a manifold with boundary hypersurfaces,  $\{N_j\}_{j=1}^k$ , and defining functions  $r_j$ . Let  $M_2$  be a manifold with boundary hypersurfaces,  $\{L_i\}_{i=1}^l$ , and defining functions  $\rho_i$ . Then  $f : M_1 \rightarrow M_2$  is called a  $b$ -map if for every  $i$  there exist nonnegative integers  $e(i, j)$  and a smooth nonvanishing function  $h$  such that  $f^*(\rho_i) = h \prod r_j^{e(i, j)}$ .

The image under a  $b$ -map of the interior of each boundary hypersurface of  $M_1$  is either contained in or disjoint from each boundary hypersurface of  $M_2$  and the order of vanishing of the differential of  $f$  is constant along each boundary hypersurface of  $M_1$ . The matrix  $(e(i, j))$  is called the lifting matrix for  $f$ .

In order for the map,  $f$ , to preserve polyhomogeneity, stronger conditions are required. Associated to a manifold with corners are the  $b$ -tangent and cotangent bundles,  ${}^bTM$  and  ${}^bT^*M$ .<sup>3</sup> The map  $f$  may be extended to induce the map  ${}^bf_* : {}^bTM_1 \rightarrow {}^bTM_2$ .

**Definition 2.10** The  $b$ -map,  $F : M_1 \rightarrow M_2$ , is called a  $b$ -fibration if the associated maps  ${}^bf_*$  at each  $p \in \partial M_1$  are surjective at each  $p \in \partial M_1$  and the lifting matrix  $(e(i, j))$  has the property that for each  $j$  there is at most one  $i$  such that  $(e(i, j)) \neq 0$ . In other words,  $f$  does not map any boundary hypersurface of  $M_1$  to a corner of  $M_2$ .

These conditions guarantee that pushforward by  $f$  preserves polyhomogeneity. We proceed with the construction of the triple heat space so that the blow down maps,  $(\beta_L)_*$ ,  $(\beta_R)_*$ , and  $(\beta_C)_*$ , to  $M_{0,h}^2$  will be  $b$ -fibrations.

In a neighborhood of the conic singularity in each copy of  $M$  we have the local coordinates  $(x, y, x', y', x'', y'', s, s')$  on  $(M \times M' \times M'' \times \mathbb{R}^+ \times \mathbb{R}^+)$ . In general when performing blow ups, if one has several submanifolds to blow up symmetrically, the corner where these submanifolds intersect is blown up first. This separates the submanifolds so that when each of them is subsequently blown up, the order of blow up does not matter and symmetry is preserved. With this in mind, we first blow up the codimension 5 submanifold,

$$S_{11122} = \{x = x' = x'' = s = s' = 0\}.$$

---

<sup>3</sup>These are also called the totally characteristic tangent and cotangent bundles.

We blow up parabolically in the  $s, s'$  directions, and radially in the  $x, x', x''$  directions. The defining function is

$$\rho_{11122} = (x^4 + (x')^4 + (x'')^4 + s^2 + (s')^2)^{\frac{1}{4}}.$$

We call this face  $F_{11122}$ . After performing this blow up we have the following radial coordinates

$$(\theta, \theta', \theta'', y, y', y'', \sigma, \sigma', \rho_{11122})$$

where

$$x = (\rho_{11122})\theta, \quad s = (\rho_{11122})^2\sigma,$$

and the coordinates  $x', x'', \sigma'$  satisfy analogous relations.

Next we consider the time variables. The three  $b$ -fibration maps onto three identical copies of  $M_{0,h}^2$  each require a time variable, but there are only two copies of  $\mathbb{R}^+$ . The three maps down to  $M_{0,h}^2$  will have time variables,  $s, s', s''$ , where the coordinates  $(s, s')$  are on  $\mathbb{R}^+ \times \mathbb{R}^+$  and

$$s'' = s' - s.$$

In order to have  $b$ -fibrations to the three copies of  $M_{0,h}^2$  we must blow up the submanifold

$$F_{00011} = \{\sigma = 0, \sigma' = 0\} - F_{11122}.$$

This blow up is radial in both directions with defining function

$$\sigma'' = (\sigma^2 + (\sigma')^2)^{\frac{1}{2}}.$$

Different notation is used for the defining function of this face because it plays the role of the third time variable.

The next step in the construction of  $M_{0,h}^3$  is to blow up the three codimension 3 corners corresponding to  $F_{112}$  in each of the three copies of  $M_{0,h}^2$ . If  $(z, z', z'', s, s')$  are local coordinates on  $M_+^3$ , then the interior of the left  $M_{0,h}^2$  has local coordinates  $(z, z', s)$ , the right has coordinates  $(z', z'', s')$ , and the center has coordinates

$(z, z'', s'')$  with  $s'' = s - s'$ . The next three blow ups are parabolic in the time directions and create the following faces.

Face	Submanifold to be blown up	Defining Function
$F_{11020}$	$S_{11010} = \{\theta = 0, \theta' = 0, s = 0\} - F_{11122}$	$\rho_{11020} = (\theta^4 + (\theta')^4 + \sigma^2)^{\frac{1}{4}}$
$F_{01102}$	$S_{01102} = \{\theta' = 0, \theta'' = 0, \sigma' = 0\} - F_{11122}$	$\rho_{01102} = ((\theta')^4 + (\theta'')^4 + (\sigma')^2)^{\frac{1}{4}}$
$F_{10122}$	$S_{10111} = \{\theta = 0, \theta'' = 0, \sigma'' = 0\} - F_{11122}$	$\rho_{10122} = (\theta^4 + (\theta'')^4 + (\sigma'')^2)^{\frac{1}{4}}$

These three faces meet at  $F_{11122}$  and share edges with each other. By blowing up the codimension 5 corner first, the order of blow up of these three faces does not matter.

Next we blow up the codimension  $2n + 2$  submanifold at which the lifts of the three diagonals meet and the time variables vanish. Let

$$S_{d3} = \{z = z', z' = z'', \sigma = 0, \sigma' = 0, \sigma'' = 0\} - (F_{11122} \cup F_{11020} \cup F_{01102} \cup F_{10111}).$$

$S_{d3}$  is blown up parabolically in  $\sigma, \sigma',$  and  $\sigma''$  creating the face  $F_{d3}$  with defining function

$$\rho_{d3} = (|z - z'|^4 + |z' - z''|^4 + \sigma^2 + (\sigma')^2 + (\sigma'')^2)^{\frac{1}{4}}.$$

Now we blow up the diagonal faces corresponding to  $F_{d2}$  in the left, right and center copies of  $M_{0,h}^2$ . These are as follows.

Face	Submanifold to be blown up	Defining Function
$F_{d20}$	$S_{d20} = \{z = z', \sigma = 0\} - (F_{11122} \cup F_{11020}),$	$\rho_{d20} = ( z - z' ^4 + \sigma^2)^{\frac{1}{4}}$
$F_{d020}$	$S_{d02} = \{z' = z'', \sigma' = 0\} - (F_{11122} \cup F_{01102})$	$\rho_{d02} = ( z' - z'' ^4 + (\sigma')^2)^{\frac{1}{4}}$
$F_{d22}$	$S_{d22} = \{z = z'', \sigma' = 0\} - (F_{11122} \cup F_{10122})$	$\rho_{d22} = ( z - z'' ^4 + (\sigma'')^2)^{\frac{1}{4}}$

The conic heat triple space has five additional boundary submanifolds.

Face	Local defining set away from blow ups	Defining Function
$F_{10000}$	$\{x = 0\}$	$\rho_{100000}$
$F_{01000}$	$\{x' = 0\}$	$\rho_{010000}$
$F_{00100}$	$\{x'' = 0\}$	$\rho_{00100}$
$F_{00010}$	$\{s = 0\}$	$\rho_{000010}$
$F_{00001}$	$\{s' = 0\}$	$\rho_{000001}$

Now we are ready to state and prove the composition rule for the conic heat calculus.

**Theorem 2.11** *Let  $A \in \Psi_{0,h}^{A_{100},A_{010},A_{112},k_a}$ , and  $B \in \Psi_{0,H}^{B_{100},B_{010},B_{112},k_b}$  with the leading index terms satisfying*

$$\beta_{112} + \alpha_{010} > 0, \quad \alpha_{112} + \beta_{100} > 0, \quad -k_a > 0, \quad -k_b > 0, \quad \beta_{100} + \alpha_{010} > -1.$$

*Then, the composition  $B \circ A$  is an element of  $\Psi_{0,H}^{A_{100},B_{010},\Gamma_{112},k}$  with  $\Gamma_{112} = A_{112} + B_{112}$  and  $k = (k_a + k_b)$ .*

### Proof

Let  $\nu$  be a smooth half density on  $M_{0,h}^2$ . Then we may write  $A = \kappa_A \nu$  and  $B = \kappa_B \nu$ . The composition of  $A$  and  $B$  is formally given by

$$\kappa_{B \circ A} = (\beta_C)_* ((\beta_R)^* (\kappa_A \nu) (\beta_L)^* (\kappa_B \nu)). \quad (2.2)$$

In verifying the composition theorem, we will refer to (2.2) often. First, we multiply both sides of (2.2) by  $\nu$ . Using the fact that  $(\beta_c)_* (\beta_c)^* (\nu) = \nu$  we have

$$\kappa_{B \circ A} \nu^2 = (\beta_C)_* ((\beta_R)^* (\kappa_A \nu) (\beta_L)^* (\kappa_B \nu) (\beta_c)^* (\nu)). \quad (2.3)$$

Now we calculate the lift to  $M_{0,h}^3$  of the smooth, nonvanishing half density  $\nu$  on  $M_{0,h}^2$ . First, we determine the relationship between  $\nu$  and the conic half density  $\mu$  on  $M_+^2$ . Recall the conic heat space  $M_{0,h}^2$  has five boundary faces with defining functions  $\rho_{100}$ ,  $\rho_{010}$ ,  $\rho_{112}$ ,  $\rho_{d2}$ , and  $\rho_{001}$ . In terms of these,

$$\nu = (\beta_h)^* \left( (\rho_{100} \rho_{010})^{\frac{1-n}{2}} (\rho_{112})^{-\frac{2n+1}{2}} (\rho_{d2})^{-\frac{n+1}{2}} \mu \right).$$

Next, we compute the lifts of the defining functions on  $M_{0,h}^2$  to the triple heat space.

Lifting map	Defining function on $M_h^2$	Lift to $M_h^3$
$(\beta_L)^*$	$\rho_{100}$	$\rho_{10000}\rho_{10122}$
$(\beta_L)^*$	$\rho_{010}$	$\rho_{01000}\rho_{01102}$
$(\beta_L)^*$	$\rho_{112}$	$\rho_{11122}\rho_{11020}$
$(\beta_L)^*$	$\rho_{d2}$	$\rho_{d3}\rho_{d20}$
$(\beta_L)^*$	$\rho_{001}$	$\rho_{00010}\rho_{00011}\rho_{d22}\rho_{10122}$
$(\beta_R)^*$	$\rho_{100}$	$\rho_{01000}\rho_{01102}$
$(\beta_R)^*$	$\rho_{010}$	$\rho_{00100}\rho_{10122}$
$(\beta_R)^*$	$\rho_{112}$	$\rho_{11122}\rho_{01102}$
$(\beta_R)^*$	$\rho_{d2}$	$\rho_{d3}\rho_{d02}$
$(\beta_R)^*$	$\rho_{001}$	$\rho_{00001}\rho_{00011}\rho_{d22}\rho_{10122}$
$(\beta_C)^*$	$\rho_{100}$	$\rho_{10000}\rho_{11020}$
$(\beta_C)^*$	$\rho_{010}$	$\rho_{001000}\rho_{01102}$
$(\beta_C)^*$	$\rho_{112}$	$\rho_{11122}\rho_{10122}$
$(\beta_C)^*$	$\rho_{d2}$	$\rho_{d3}\rho_{d22}$
$(\beta_C)^*$	$\rho_{001}$	$\rho_{00022}\rho_{00011}\rho_{d22}\rho_{10122}$

We will use the fact that

$$(\beta_L)^*(\mu)(\beta_R)^*(\mu)(\beta_C)^*(\mu) = \mu_3^2.$$

Here,  $\mu_3^2$  is the smooth conic density on  $M_0 \times M_0 \times M_0 \times \mathbb{R}^+ \times \mathbb{R}^+$ , so we may assume

$$\mu_3^2 = dV_c dt dt' = (xx'x'')^{n-1} dz dz' dz'' dt dt'.$$

A calculation of Jacobians gives the lift of  $\mu_3^2$  to the triple heat space. First note

$$(\beta_3)^*(x) = \rho_{11122}\rho_{11020}\rho_{10122}\rho_{10000},$$

$$(\beta_3)^*(x') = \rho_{11122}\rho_{11020}\rho_{01102}\rho_{01000},$$

$$(\beta_3)^*(x'') = \rho_{11122}\rho_{10122}\rho_{11020}\rho_{00100}.$$

In the Jacobian calculations we observe that the exponent of each defining function is  $-1 +$  the number of space dimensions  $+ 2$  times the number of time dimensions

in that defining function. This is because the blow ups in the  $t$ -directions are parabolic while the other directions are blown up radially.

$\mu_3^2$  lifts to  $M_{0,h}^3$  as follows

$$\begin{aligned} (\beta_3)^*(\mu_3^2) &= (\rho_{11122})^{3n-3}((\rho_{11020})(\rho_{01102})(\rho_{10122}))^{2n+1}(\rho_{d3})^{2n+3} \\ &((\rho_{d20})(\rho_{d02})(\rho_{d22}))^{n+1}((\rho_{10000})(\rho_{10000})(\rho_{10000}))^{n-1}(\rho_{00022})\nu_3^2. \end{aligned}$$

Here,  $\nu_3^2$  is a smooth, nonvanishing density on  $M_{0,h}^3$ . These calculations show

$$\begin{aligned} (\beta_L)^*(\nu)(\beta_R)^*(\nu)(\beta_C)^*(\nu) &= \\ &((\rho_{11122})(\rho_{11020})(\rho_{01102})(\rho_{10122}))^{\frac{3}{2}}(\rho_{d3})^{\frac{n+3}{2}}((\rho_{d20})(\rho_{d02})(\rho_{d22}))^{\frac{n+1}{2}}\rho_{00022}\nu_3^2. \end{aligned}$$

We use this result in to obtain

$$\begin{aligned} \kappa_{B \circ A} \nu^2 &= (\beta_C)_*((\beta_R)^*(\kappa_A)(\beta_L)^*(\kappa_B)((\rho_{11122})(\rho_{11020})(\rho_{01102})(\rho_{10122}))^{\frac{3}{2}} \\ &(\rho_{d3})^{\frac{n+3}{2}}((\rho_{d20})(\rho_{d02})(\rho_{d22}))^{\frac{n+1}{2}}(\rho_{00022})\nu_3^2). \end{aligned} \quad (2.4)$$

To use the push forward theorem of [21], we must write this as a  $b$ -density. On the center copy of  $M_{0,h}^2$

$${}^b\nu^2 = (\rho_{100}\rho_{010}\rho_{112}\rho_{d2}\rho_{001})^{-1}\nu^2.$$

Then, we have

$${}^b\nu^2 = (\beta_C)_*(\beta_C)^*(\rho_{100}\rho_{010}\rho_{112}\rho_{d2}\rho_{001})^{-1}\nu^2.$$

We observe

$$\begin{aligned} (\beta_C)^*((\rho_{100}\rho_{010}\rho_{112}\rho_{d2}\rho_{001})^{-1}) &= \\ &((\rho_{10000})(\rho_{10000})''(\rho_{11020})(\rho_{01102})(\rho_{10122})(\rho_{11122})(\rho_{d3})(\rho_{d22})\rho_{00011})^{-1}. \end{aligned}$$

So now in (2.4) we must multiply both sides by  $(\beta_C)_*(\beta_C)^*((\rho_{100}\rho_{010}\rho_{112}\rho_{d2}\rho_{001})^{-1})^{-1}$  to obtain

$$\kappa_{B \circ A} {}^b\nu^2 = (\beta_C)_*[\tilde{\kappa}_A\tilde{\kappa}_B((\rho_{10000})^{-1}((\rho_{10000}))^{-1}) \quad (2.5)$$

$$(\rho_{11122})(\rho_{11020})(\rho_{01102})(\rho_{10122})^{\frac{1}{2}}((\rho_{d3})(\rho_{d20})(\rho_{d02}))^{\frac{n+1}{2}}(\rho_{d22})^{\frac{n-1}{2}}\nu_3^2].$$

Here, we are using  $\tilde{\kappa}_A$  and  $\tilde{\kappa}_B$  to denote the lifts of  $\kappa_A$  and  $\kappa_B$ , respectively, to the triple heat space,  $M_h^3$ .

To use the push forward theorem, we must also change the density  $\nu_3^2$  to a  $b$ -density. We observe

$${}^b\nu_3^2 = ((\rho_{11122})(\rho_{11020})(\rho_{01102})(\rho_{10122})(\rho_{10000})\theta'_0\theta''_0(\rho_{d3})(\rho_{d20})(\rho_{d02})(\rho_{d22})\tau_0\sigma_0\sigma'_0)^{-1}\nu_3^2.$$

So, we now have

$$\kappa_{B \circ A} {}^b\nu^2 = (\beta_C)_*[\tilde{\kappa}_A\tilde{\kappa}_B((\rho_{11122})(\rho_{11020})(\rho_{01102})(\rho_{10122}))^{\frac{3}{2}}] \quad (2.6)$$

$$((\rho_{d3})(\rho_{d20})(\rho_{d02}))^{\frac{n+3}{2}}(\rho_{d22})^{\frac{n+1}{2}}(\rho_{10000})\sigma_0\sigma'_0\tau_0 {}^b\nu_3^2].$$

Now, we may use the push forward theorem. The boundary faces  $F_{11020}$ ,  $F_{01102}$ ,  $F_{d20}$ ,  $F_{d02}$ , and  $F_{01000}$  are all mapped to the interior of  $M_{0,h}^2$  by  $(\beta_C)_*$ . The theorem demands the quantity to be pushed forward be integrable with respect to the  $b$ -density at these boundary faces. By hypothesis  $\kappa_A$  is smooth in the interior of  $M_{0,h}^2$  and has the following expansions on the boundary faces of  $M_{0,h}^2$

Face	$\kappa_A$ Index Set/Leading Order
$F_{112}$	$A_{112}$
$F_{100}$	$A_{100}$
$F_{010}$	$A_{010}$
$F_{d2}$	$-\frac{n+3}{2} - k_a$
$F_{001}$	$\infty$

Then, by the previous calculations determining the lifts of the defining functions of  $M_{0,h}^2$  under  $(\beta_L)^*$  we have the following orders of  $\tilde{\kappa}_A$  on  $M_{0,h}^3$ .

Face	$\tilde{\kappa}_A$ Index Set/Leading Order
$F_{11122}, F_{11020}$	$A_{112}$
$F_{01102}, F_{01000}$	$A_{010}$
$F_{10122}, F_{d22}, F_{00010}, F_{00011}$	$\infty$
$F_{d3}, F_{d20}$	$-\frac{n+3}{2} - k_a$
$F_{10000}$	$A_{100}$
$F_{00100}$	0

The expansions and leading order terms of  $\kappa_B$  on  $M_{0,h}^2$  are as follows.

Face	$\kappa_B$ Index Set/Leading Order
$F_{112}$	$B_{112}$
$F_{100}$	$B_{100}$
$F_{010}$	$B_{010}$
$F_{d2}$	$-\frac{n+3}{2} - k_b$
$F_{001}$	$\infty$

Similarly, for  $\tilde{\kappa}_B$  we have orders as follows.

Face	$\tilde{\kappa}_B$ Index Set/Leading Order
$F_{11122}, F_{11010}$	$B_{112}$
$F_{01102}, F_{01000}$	$B_{010}$
$F_{10122}, F_{d22}, F_{00001}, F_{00011}$	$\infty$
$F_{d3}, F_{d02}$	$-\frac{n+3}{2} - k_b$
$F_{10000}$	$B_{100}$
$F_{00100}$	0

Now, recalling the formula,

$$\kappa_{B \circ A} {}^b \nu^2 = (\beta_C)_* [\tilde{\kappa}_A \tilde{\kappa}_B ((\rho_{11122})(\rho_{11020})(\rho_{01102})(\rho_{10122}))^{\frac{3}{2}} ((\rho_{d3})(\rho_{d20})(\rho_{d02}))^{\frac{n+3}{2}} (\rho_{d22})^{\frac{n+1}{2}} (\rho_{10000}) \rho_{00010} {}^b \nu_3^2],$$

we see that the quantity on the right hand side to be pushed forward by  $(\beta_c)_*$  has the following behavior on the boundary faces.



Face	Index Set/Leading Order
$F_{11122}$	$-\frac{3}{2} + A_{112} + B_{112}$
$F_{11020}$	$A_{112} + B_{100}$
$F_{01102}$	$A_{010} + B_{112}$
$F_{10122}, F_{d22}, F_{00010}, F_{00001}, F_{00011}$	$\infty$
$F_{d3}$	$-\frac{n+3}{2} - (k_a + k_b)$
$F_{d20}$	$-k_a$
$F_{d02}$	$-k_b$
$F_{10000}$	$A_{100}$
$F_{01000}$	$A_{010} + B_{100} + 1$
$F_{00100}$	$B_{010}$

The following table shows the leading order of the quantity to be pushed forward and where the boundary faces of  $M_{0,h}^3$  are pushed forward by  $(\beta_C)_*$  in  $M_{0,h}^2$ .

$M_{0,h}^3$ Face	$M_{0,h}^2$ Face or Interior	Leading Order of Composition
$F_{11122}$	$F_{112}$	$-\frac{3}{2} + \alpha_{112} + \beta_{112}$
$F_{11020}$	Interior	$\alpha_{112} + \beta_{100}$
$F_{01102}$	Interior	$\beta_{112} + \alpha_{010}$
$F_{10122}$	$F_{112}$	$\infty$
$F_{d3}$	$F_{d2}$	$-\frac{n+3}{2} - (k_a + k_b)$
$F_{d20}$	Interior	$-k_a$
$F_{d02}$	Interior	$-k_b$
$F_{d22}$	$F_{d2}$	$\infty$
$F_{10000}$	$F_{100}$	$\alpha_{100}$
$F_{01000}$	Interior	$\beta_{100} + \alpha_{010} + 1$
$F_{00100}$	$F_{010}$	$\beta_{010}$
$F_{00010}, F_{00001}$	Interior	$\infty$
$F_{00011}$	$F_{001}$	$\infty$

Note that by hypotheses of the theorem,

$$\alpha_{112} + \beta_{100} > 0, \beta_{112} + \alpha_{010} > 0, -k_a > 0, -k_b > 0, \text{ and } \beta_{100} + \alpha_{010} > -1.$$

Therefore, the quantity to be pushed forward is integrable with respect to  ${}^b\nu_3^2$  at

$F_{01102}$ ,  $F_{11020}$ ,  $F_{d02}$ ,  $F_{d20}$ , and  $F_{01000}$ . This allows us to apply the push forward theorem using  $(\beta_C)_*$ . The kernel of the composition  $\kappa_{B \circ A}$  then pushes forward to  $M_{0,h}^2$  to have the following index sets and leading orders.

Face	Index Set/Leading Order
$F_{112}$	$-\frac{3}{2} + A_{112} + B_{112}$
$F_{100}$	$A_{100}$
$F_{010}$	$B_{010}$
$F_{d2}$	$-\frac{n+3}{2} - (k_a + k_b)$
$F_{001}$	$\infty$

This completes the proof of the composition rule. We conclude that the composition  $B \circ A$  is an element of  $\Psi_{0,H}^{A_{100}, B_{010}, \Gamma_{112}, k}$  with  $\Gamma_{112} = -\frac{3}{2} + A_{112} + B_{112}$  and  $k = (k_a + k_b)$ .

♡

### Parametrix Construction of Conic Heat Kernel

Since the first approximation to the conic heat kernel is an element of the calculus we can use the composition rule to produce a parametrix for the heat operator with error term vanishing to infinite order on  $F_{112}$ ,  $F_{d2}$ , and  $F_{001}$ . As seen previously, the first approximation for the heat kernel is of the form  $(\rho_{112})^{-1}(\rho_{100}\rho'_{010})^{-n}H_0(x, x', y, y', t)$ . It has leading orders on  $M_{0,h}^2$  as follows.

Boundary Face of $M_{0,h}^2$	Leading order
$F_{112}$	$-1 + \nu_0$
$F_{100}$	$-n + \mu_0$
$F_{010}$	$-n + \mu_0$
$F_{d2}$	$-n$
$F_{001}$	$\infty$

The density factor has not yet been included. The lift of the conic half density to the heat space is  $(\beta_h)^*(\mu) = (\rho_{100}\rho_{010})^{\frac{n-1}{2}}(\rho_{112})^{\frac{2n+1}{2}}(\rho_{d2})^{\frac{n+1}{2}}\nu$ . Therefore, on the heat space the model operator is

$$(\rho_{100}\rho_{010})^{\frac{-n-1}{2}}(\rho_{112})^{\frac{2n-1}{2}}(\rho_{d2})^{\frac{n+1}{2}}H_0\nu.$$

As an element of the heat calculus the kernel  $\kappa_0$  of the first parametrix has the following leading orders at the boundary faces of  $M_{0,h}^2$ .

Face	Leading Order
$F_{112}$	$-\frac{3}{2} + \frac{2n+1}{2} + \nu_0$
$F_{100}$	$\frac{-n-1}{2} + \mu_0$
$F_{010}$	$\frac{-n-1}{2} + \mu_0$
$F_{d2}$	$-\frac{n+3}{2} - (-2)$
$F_{001}$	$\infty$

**Theorem 2.12** *Let  $(M_0, g_0)$  be a compact manifold with isolated conic singularity, with geometric Laplacian  $\Delta$  associated to the Hermitian vector bundle  $(E, \nabla)$  over  $(M_0, g_0)$ . Assume the bundle retracts onto a bundle over the cross section,  $(Y, h)$ . Then there exists  $H \in \Psi_{0,H}^{E_{100}, E_{010}, E_{112}, -2}$  satisfying*

$$(\partial_t + \Delta)H(z, z', t) = 0, t > 0,$$

$$H(z, z', 0) = \delta(z - z'),$$

where  $\Delta$  is the Friedrich's extension of this geometric Laplacian. The index sets  $E_{100}$ ,  $E_{010}$  have leading order  $\frac{-1-n}{2} + \mu_0$  and the index set  $E_{112}$  has leading order  $\frac{2n-1}{2} + \nu_0$ . Here,  $\mu_0$  and  $\nu_0$  are determined by the eigenvalues of the induced geometric Laplacian on the cross section of  $M$ , the dimension  $n$  of  $M$ , and the rank of the bundle.

**Proof**

The first order approximation is defined locally near the boundary faces of  $M_{0,h}^2$  as above and on the interior by the lift of the Euclidean heat kernel to  $M_{0,h}^2$ , using smooth cut-off functions to patch these approximations together. The result is an element of the heat calculus,  $H_1$ . Applying  $(\partial_t + \Delta)$  to  $H_1$  gives

$$(\partial_t + \Delta)H_1 = EH_1 =: K_1.$$

Here,  $E$  is the error term seen previously. As an element of the heat calculus,  $K_1$  has leading orders

Face	Leading Order
$F_{112}$	$-\frac{3}{2} + \frac{2n-1}{2}$
$F_{100}$	$\frac{-1-n}{2} + \nu_0$
$F_{010}$	$\frac{-1-n}{2} + \nu_0$
$F_{d2}$	$-\frac{n+3}{2} - (-2)$
$F_{001}$	$\infty$

Motivated by Duhamel's Principle, let

$$H_2 = H_1 - H_1 K_1.$$

By the composition formula,  $H_2$  has leading orders

Face	Leading Order
$F_{112}$	$-\frac{3}{2} + \frac{2n-1}{2} + \frac{2n+1}{2}$
$F_{100}$	$\frac{-1-n}{2} + \nu_0$
$F_{010}$	$\frac{-1-n}{2} + \nu_0$
$F_{d2}$	$-\frac{n+3}{2} - (-2 - 2)$
$F_{001}$	$\infty$

Continuing this construction, let

$$H_3 = H_1 - H_1 * K_1 + H_1 * K_1 * K_1,$$

$$H_j = H_1 + \sum_{i=1}^j (-1)^i H_1 (K_1)^i.$$

The last term in the sum has leading orders

Face	Index Set/Order of Vanishing
$F_{112}$	$-\frac{3}{2} + \frac{2n-1}{2}j + \frac{2n+1}{2}$
$F_{100}$	$\frac{-1-n}{2} + \nu_0$
$F_{010}$	$\frac{-1-n}{2} + \nu_0$
$F_{d2}$	$-\frac{n+3}{2} + 2(j+1)$
$F_{001}$	$\infty$

Borel summation gives existence of  $H_\infty$  with asymptotic expansion such that

$$H_\infty = \lim_{j \rightarrow \infty} H_j.$$

$H_\infty$  solves the heat equation up to infinite order on  $M_{0,h}^2$ . Let  $H$  be the full conic heat kernel. Then,  $H - H_\infty = K$  vanishes to infinite order at the  $F_{112}$ ,  $F_{d2}$ , and  $F_{001}$  boundary faces of  $M_{0,h}^2$ , has a polyhomogeneous expansion up to  $F_{100}$  and  $F_{010}$  and vanishes to infinite order at  $t = 0$ . Parabolic regularity implies that  $K$  is smooth on the interior of  $M_{0,h}^2$  and consequently is an element of the conic heat calculus. The full heat kernel is

$$H = H_\infty + K.$$

By construction,  $H$  is an element of the heat calculus,  $H = \kappa \nu$  with  $\kappa$  having leading orders

Face	$\kappa$ Leading Order
$F_{112}$	$-\frac{3}{2} + \frac{2n+1}{2}$
$F_{100}$	$\frac{-1-n}{2} + \nu_0$
$F_{010}$	$\frac{-1-n}{2} + \nu_0$
$F_{d2}$	$-\frac{n+3}{2} - (-2)$
$F_{001}$	$\infty$

This completes our construction of the conic heat kernel. For a detailed study of the special case of the scalar heat kernel on the exact cone over  $(Y, h)$ , see appendix A.

♡

## 2.13 AC Heat Kernel

Let  $\bar{Z}$  be a compactified ac space with boundary defined by  $\{x = 0\}$  and local coordinates  $(x, y)$  near the boundary. Let  $\Delta_z$  be the Friedrich's extension of a geometric Laplacian on  $Z$ . The heat kernel for  $(\partial_t + \Delta_z)$  has the usual behavior away from the boundary of  $\bar{Z}$  and at  $t = 0$ . The interesting behavior occurs near

the boundary of  $\bar{Z}$ . Our first approximation for the ac heat is the Euclidean heat kernel lifted to a neighborhood of the boundary in  $\bar{Z} \times \bar{Z} \times \mathbb{R}^+$ . Recall the Euclidean heat kernel for  $\mathbb{R}^n$ ,

$$G(z, z', t) = (4\pi t)^{-\frac{n}{2}} e^{-\frac{|z-z'|^2}{2t}}.$$

Here the coordinate  $z = (r, y)$  has not been compactified. With the compactification of  $Z$ ,  $x = \frac{1}{r}$  and in the local coordinates,  $(x, y, x', y', t)$  on  $\bar{Z}_+^2$  near the boundary of  $\bar{Z}$  the Euclidean heat kernel has the following form

$$G(x, y, x', y', t) = (4\pi t)^{-\frac{n}{2}} \exp\left(-\frac{\left(\frac{1}{x} - \frac{1}{x'}\right)^2 + |y - y'|^2}{2t}\right).$$

This motivates blowing up

$$S_{110} = \{(x, y, x', y', t) : x = 0, x' = 0\}.$$

In the projective coordinates  $s = \frac{x}{x'}$ ,  $s' = x'$  the Euclidean heat kernel is

$$G(s, y, s', y', t) = (4\pi t)^{-\frac{n}{2}} \exp\left(-\frac{\left(\frac{s-1}{ss'}\right)^2 + |y - y'|^2}{2t}\right).$$

This motivates a second blow up at  $s = 1$ , along the submanifold where the diagonal in  $\bar{Z} \times \bar{Z}$  meets the first blown up face

$$S_{220} = \{(x, y, x', y', t) : x = 0, x' = 0, y = y'\}.$$

### 2.13.1 The AC Heat Space

As motivated above, the ac heat space is constructed from  $\bar{Z} \times \bar{Z} \times \mathbb{R}^+$  by performing three blow ups.

First we construct the ac double space,  $\bar{Z}_{sc}^2$ .<sup>4</sup> This construction comes from [12]. We take  $\bar{Z} \times \bar{Z}$  and blow up the codimension two corner  $\{x = 0, x' = 0\} = (\partial\bar{Z})^2$ . This is the  $b$ -blow up of  $\bar{Z} \times \bar{Z}$ ,  $\bar{Z}_b^2$ . The new face created by this blow up is  $F_{110}$

<sup>4</sup>The subscript “sc” in  $\bar{Z}_{sc}^2$  is for scattering because ac spaces are also called scattering spaces.

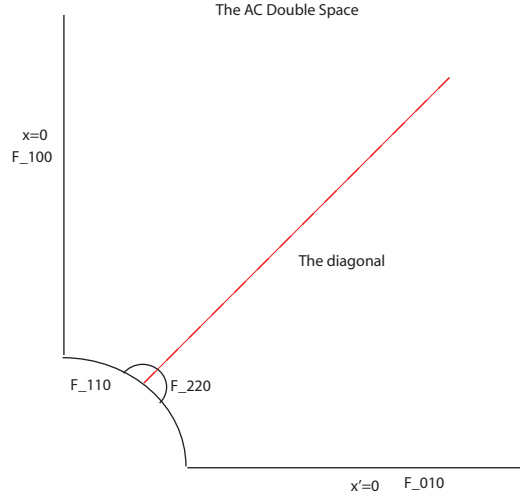

Figure 2.4: The ac double space.

with defining function

$$\rho_{110} = (x^2 + (x')^2)^{\frac{1}{2}}.$$

We have new coordinates  $(\rho_{110}, \theta, \theta', y, y')$  near the blow up with  $x = (\rho_{110})\theta$ ,  $x' = (\rho_{110})\theta'$ , where  $\theta, \theta' \in \mathbb{S}^1$  and  $\theta^2 + (\theta')^2 = 1$ . Next we blow up the intersection of the diagonal with this face, creating the face  $F_{220}$  with defining function

$$\rho_{220} = ((\rho_{110})^2 + (\theta - \theta')^2 + |y - y'|^2)^{\frac{1}{2}}.$$

The result of these two blow ups is the ac double space,

$$\bar{Z}_{sc}^2 = [\bar{Z}_b^2; \partial \text{diag}_b] = [[\bar{Z} \times \bar{Z}; \partial \bar{Z} \times \partial Z]; \Delta(Z \times Z) \cap F_{110}].$$

Finally, we take  $\bar{Z}_{sc}^2 \times \mathbb{R}^+$  and blow up the diagonal at  $t = 0$ , creating the face  $F_{d2}$  with defining function

$$\rho_{d2} = (|z - z'|^4 + t^2)^{\frac{1}{4}} \text{ for } z, z' \notin F_{110}, F_{220}.$$

The ac heat space,  $\bar{Z}_h^2$ , has six boundary faces described in the following table.

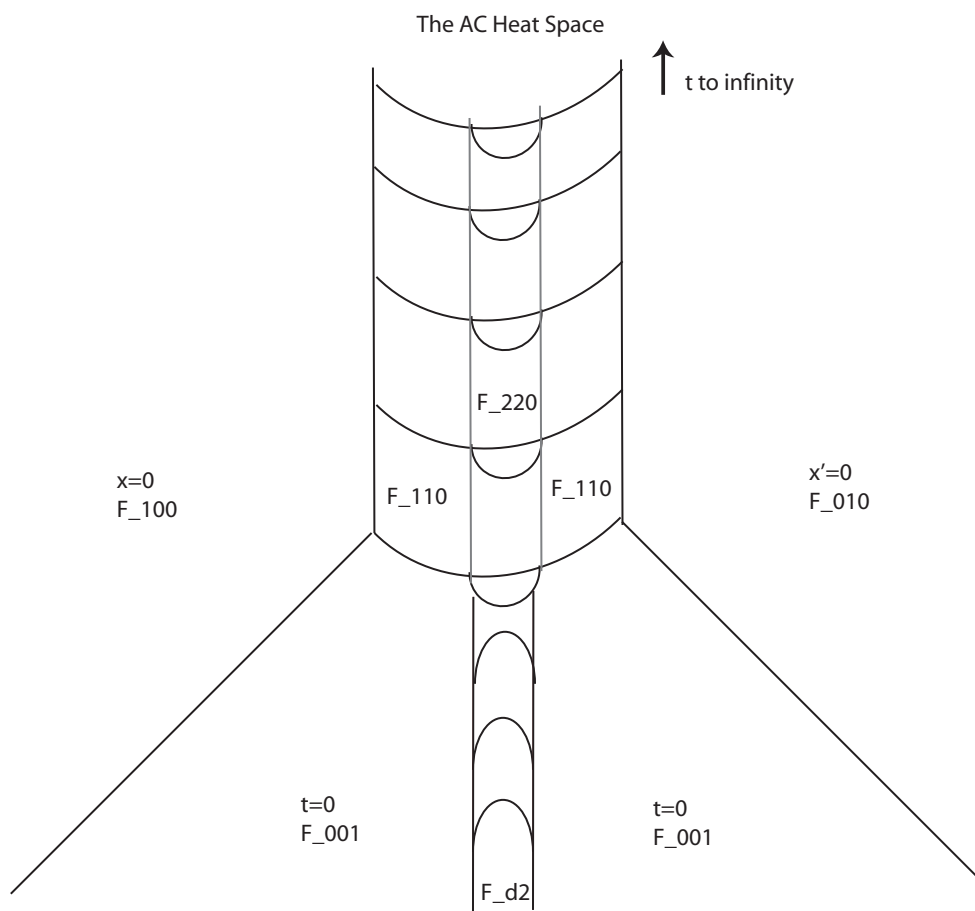

Figure 2.5: The ac heat space.

Boundary face of $\bar{Z}_h^2$	Blow up of/ Locally defined by
$F_{110}$	Blowup of $\{x = 0, x' = 0\}$
$F_{220}$	Blowup of $\{y = y'\} \cap F_{110}$
$F_{100}$	$\{x = 0\} - F_{110}, F_{220}$
$F_{010}$	$\{x' = 0\} - F_{110}, F_{220}$
$F_{d2}$	Blowup of $\{x = x', y = y', t = 0\} - F_{220}$
$F_{001}$	$\{t = 0\} - F_{d2}$



### 2.13.2 AC Heat Calculus

Elements of the ac heat calculus are distributional section half densities of  $Z$  with polyhomogeneous expansions up to the boundary faces of the ac heat space and specified leading order at each boundary face. Let  $\mu$  be a smooth, non-vanishing half density on  $\bar{Z} \times \bar{Z} \times \mathbb{R}^+$  and let  $\nu$  be a smooth, non-vanishing half density on the ac heat space.

**Definition 2.14** *For any  $k \in \mathbb{R}$  and index sets  $E_{110}$ ,  $E_{220}$ ,  $A$  is an element of the ac heat calculus  $\Psi_{ac,H}^{E_{110},E_{220},k}$  if the following hold.*

1.  $A \in \mathcal{A}_{phg}^{-\frac{1}{2}+E_{110}}(F_{110})$ .
2.  $A \in \mathcal{A}_{phg}^{-\frac{n+2}{2}+E_{220}}(F_{220})$ .
3.  $A$  vanishes to infinite order at  $F_{001}$ ,  $F_{100}$ , and  $F_{010}$ .
4.  $A \in \rho_{d2}^{-\frac{n+3}{2}-k} \mathcal{C}^\infty(F_{d2})$ .

As with the conic heat calculus, we view elements of the ac heat calculus as Schwartz kernels of operators acting on sections of  $Z$ . To prove the composition rule we must construct the ac triple heat space to have partial blow down/projection maps to three identical copies of the ac heat space as well as full blow down/projection maps to identical copies of  $\bar{Z}_+$ .

#### The AC Triple Heat Space

As with the construction of the ac double space, we begin with three copies of  $\bar{Z}$  and include the time variables after performing a sequence of blow ups. In a neighborhood of the boundary in each copy of  $\bar{Z}$  we have the local coordinates  $(x, y)$ , which provide the local coordinates  $(x, y, x', y', x'', y'')$  on  $\bar{Z}^3$ . First we blow up the codimension three corner defined by  $\{x = 0, x' = 0, x'' = 0\}$ . We call this face  $F_{11100}$  with defining function

$$\rho_{11100} = (x^2 + (x')^2 + (x'')^2)^{\frac{1}{2}}.$$

Next, we blow up the three codimension two corners corresponding to the  $F_{110}$  faces in each of the three copies of the ac heat space. These faces are as follows.

Face	Submanifold to be blown up	Defining Function
$F_{11000}$	$S_{11000} = \{x = 0, x' = 0\} - F_{11100}$	$\rho_{11000} = (x^2 + (x')^2)^{\frac{1}{2}}$
$F_{01100}$	$S_{01100} = \{x' = 0, x'' = 0\} - F_{11100}$	$\rho_{01100} = ((x')^2 + (x'')^2)^{\frac{1}{2}}$
$F_{10100}$	$S_{10100} = \{x = 0, x'' = 0\} - F_{11100}$	$\rho_{10100} = ((x)^2 + (x'')^2)^{\frac{1}{2}}$

The next step in constructing the ac triple heat space is to blow up the codimension  $2n + 1$  corner where the diagonals meet  $F_{11100}$ . After the  $F_{11100}$  blow up, we have coordinates  $(\theta, \theta', \theta'', y, y', y'', \rho_{11100})$ , with

$$x = (\rho_{11100})\theta, \quad x' = (\rho_{11100})\theta', \quad x'' = (\rho_{11100})\theta'', \quad (\theta)^2 + (\theta')^2 + (\theta'')^2 = 1.$$

Using these coordinates, we next blow up

$$S_{22200} = \{\theta = \theta' = \theta'', y = y' = y'', r_0 = 0\}.$$

The face created by this blow up is called  $F_{22200}$  with defining function

$$\rho_{22200} = ((\theta - \theta')^2 + (\theta' - \theta'')^2 + |y - y'|^2 + |y' - y''|^2 + r_0^2)^{\frac{1}{2}}.$$

After this we blow up the three codimension  $n$  corners corresponding to the  $F_{220}$  faces in the three copies of the double heat space. These are as follows.

Face	Submanifold to be blown up	Defining Function
$F_{22000}$	$S_{22000} = \{\theta = 0, \theta' = 0, y = y'\}$	$\rho_{22000} = (\theta^2 + (\theta')^2 +  y - y' ^2)^{\frac{1}{2}}$
$F_{02200}$	$S_{02200} = \{\theta' = 0, \theta'' = 0, y' = y''\}$	$\rho_{02200} = ((\theta')^2 + (\theta'')^2 +  y' - y'' ^2)^{\frac{1}{2}}$
$F_{20200}$	$S_{20200} = \{\theta = 0, \theta'' = 0, y = y''\}$	$\rho_{20200} = ((\theta)^2 + (\theta'')^2 +  y - y'' ^2)^{\frac{1}{2}}$

We have now constructed the ac triple space,  $\bar{Z}_{sc}^3$ . We next introduce the time variables and perform the parabolic temporal diagonal blow ups. We must first blow up the codimension 2 corner of  $\mathbb{R}^+ \times \mathbb{R}^+$  to preserve symmetry. Let

$$\mathcal{T}_0^2 = [\mathbb{R}^+ \times \mathbb{R}^+; t = t' = 0],$$

where this is a standard radial blow up. The defining function for the blow up of

$\{t = t' = 0\}$  is  $\rho_{00011}$ , which we call  $t''$  because it plays the role of the third time variable. We now take  $Z_{sc}^3 \times \mathcal{T}_0^2$  and blow up the temporal diagonal faces. First, we blow up the codimension  $2n + 3$  triple diagonal,  $S_{d3}$ , defined by

$$\{z = z' = z'', t'' = 0\}.$$

The defining function of this face is  $\rho_{d3}$ ,

$$\rho_{d3} = (|z - z'|^4 + |z - z''|^4 + (t'')^2)^{\frac{1}{4}}.$$

Next, we blow up the three temporal diagonals corresponding to the diagonal faces in the three copies of the double heat space. These are as follows.

Face	Submanifold to be blown up	Defining Function
$F_{d20}$	$S_{d20} = \{z = z'\}$	$\rho_{d20} = ( z - z' ^4 + t^2)^{\frac{1}{4}}$
$F_{d02}$	$S_{d02} = \{z' = z''\}$	$\rho_{d02} = ( z' - z'' ^4 + (t')^2)^{\frac{1}{4}}$
$F_{d22}$	$S_{d22} = \{z = z''\}$	$\rho_{d22} = ( z - z'' ^4 + (t'')^2)^{\frac{1}{4}}$

This completes our construction of the ac triple heat space.

**Theorem 2.15** *Let  $A \in \Psi_{ac,H}^{A_{110}, A_{220}, k_a}$ , and  $B \in \Psi_{ac,H}^{B_{110}, B_{220}, k_b}$ .*

*Then, the composition  $B \circ A$  is an element of  $\Psi_{ac,H}^{A_{110} + B_{110}, A_{220} + B_{220}, k_a + k_b}$ .*

### Proof

To prove this theorem, as with the conic case, we work with the equation,

$$\kappa_{B \circ A} \nu = (\beta_C)_* ((\beta_R)^* (\kappa_A \nu) (\beta_L)^* (\kappa_B \nu)). \quad (2.7)$$

Multiplying both sides of (2.7) by  $\nu$  and using the fact that  $(\beta_C)_* (\beta_C)^* (\nu) = \nu$  we have

$$\kappa_{B \circ A} \nu^2 = (\beta_C)_* ((\beta_R)^* (\kappa_A \nu) (\beta_L)^* (\kappa_B \nu) (\beta_C)^* (\nu)). \quad (2.8)$$

We next calculate the lifts of the defining functions and half densities from the heat space to the triple heat space. A calculation gives the half density on the heat space,  $\nu$ , in terms of the half density,  $\mu$ , on  $\bar{Z}_+^2$

$$\nu = (\beta_h)^* \left( (\rho_{110})^{-\frac{1}{2}} (\rho_{220})^{-\frac{n}{2}} (\rho_{d2})^{-\frac{n+1}{2}} \mu \right).$$

As with the conic triple heat space, the ac triple heat space has partial blow down/projection maps  $\beta_L, \beta_R,$  and  $\beta_C$  to three identical copies of  $\bar{Z}_h^2$ . If we denote the three copies of  $\bar{Z}$  by  $\bar{Z}, \bar{Z}', \bar{Z}''$ , and the three time variables  $(t, t', t'')$  where  $t''$  is from the blow up of  $\mathbb{R}^+ \times \mathbb{R}^+$  then the three copies of  $\bar{Z}_h^2$  are as follows.

Copy of $\bar{Z}_h^2$	Associated to in $\bar{Z}_h^3$
Left	$\bar{Z} \times \bar{Z}' \times \mathbb{R}_t^+$
Right	$\bar{Z}' \times \bar{Z}'' \times \mathbb{R}_{t'}^+$
Center	$\bar{Z} \times \bar{Z}'' \times \mathbb{R}_{t''}^+$

Next, we compute the lifts of the defining functions for the boundary faces of the heat space to the triple heat space.

Lifting map	Defining function on $\bar{Z}_h^2$	Lift to $\bar{Z}_h^3$
$(\beta_L)^*$	$\rho_{100}$	$\rho_{10000}\rho_{10100}$
$(\beta_L)^*$	$\rho_{010}$	$\rho_{01000}\rho_{01100}$
$(\beta_L)^*$	$\rho_{110}$	$\rho_{11100}\rho_{11000}$
$(\beta_L)^*$	$\rho_{220}$	$\rho_{22200}\rho_{22000}$
$(\beta_L)^*$	$\rho_{d2}$	$\rho_{d3}\rho_{d20}$
$(\beta_L)^*$	$\rho_{001}$	$\rho_{00010}\rho_{00011}\rho_{d22}$
$(\beta_R)^*$	$\rho_{100}$	$\rho_{01000}\rho_{01100}$
$(\beta_R)^*$	$\rho_{010}$	$\rho_{00100}\rho_{10100}$
$(\beta_R)^*$	$\rho_{110}$	$\rho_{11100}\rho_{01100}$
$(\beta_R)^*$	$\rho_{220}$	$\rho_{22200}\rho_{02200}$
$(\beta_R)^*$	$\rho_{d2}$	$\rho_{d3}\rho_{d02}$
$(\beta_R)^*$	$\rho_{001}$	$\rho_{00001}\rho_{00011}\rho_{d22}$
$(\beta_C)^*$	$\rho_{100}$	$\rho_{10000}\rho_{11000}$
$(\beta_C)^*$	$\rho_{010}$	$\rho_{001000}\rho_{01100}$
$(\beta_C)^*$	$\rho_{110}$	$\rho_{11100}\rho_{10100}$
$(\beta_C)^*$	$\rho_{220}$	$\rho_{22200}\rho_{20200}$
$(\beta_C)^*$	$\rho_{d2}$	$\rho_{d3}\rho_{d22}$
$(\beta_C)^*$	$\rho_{001}$	$\rho_{00022}\rho_{00011}\rho_{d22}$

Then, we have

$$(\beta_L)^*(\nu) = (\beta_L)^*((\rho_{110})^{-\frac{1}{2}}(\rho_{220})^{-\frac{n}{2}}(\rho_{d2})^{-\frac{n+1}{2}}\mu).$$

Next, we will use the fact that

$$(\beta_L)^*(\mu)(\beta_R)^*(\mu)(\beta_C)^*(\mu) = \mu_3^2.$$

Here,  $\mu_3^2$  is a smooth density on  $\bar{Z} \times \bar{Z} \times \bar{Z} \times \mathbb{R}^+ \times \mathbb{R}^+$ , so we may assume

$$\mu_3^2 = dzdz'dz''dtdt'.$$

A Jacobian calculation gives the lift of  $\mu_3^2$  to the triple heat space. First note

$$(\beta_3)^*(x) = (\rho_{11100})(\rho_{11000})(\rho_{10100})(\rho_{10000}),$$

$$(\beta_3)^*(x') = (\rho_{11100})(\rho_{11000})(\rho_{01100})(\rho_{01000}),$$

$$(\beta_3)^*(x'') = (\rho_{11100})(\rho_{01100})(\rho_{10100})(\rho_{00100}).$$

This implies

$$(\beta_3)^*(\mu_3^2) = (\rho_{11100})^2(\rho_{11000}\rho_{01100}\rho_{10100})(\rho_{22000}\rho_{02200}\rho_{20200})^n$$

$$(\rho_{22200})^{2n+1}(\rho_{d20}\rho_{d02}\rho_{d22})^{n+1}\rho_{d3}^{2n+3}(t'')\nu_3^2.$$

Here,  $\nu_3^2$  is a smooth, nonvanishing density on the triple heat space,  $\bar{Z}_h^3$ . Combining this with the above lifts, we arrive at the following formula

$$(\beta_L)^*(\nu)(\beta_R)^*(\nu)(\beta_C)^*(\nu) = (\rho_{11100})^{\frac{1}{2}}(\rho_{10100}\rho_{01100}\rho_{10100})^{\frac{1}{2}}$$

$$(\rho_{22000}\rho_{02200}\rho_{20200})^{\frac{n}{2}}(\rho_{22200})^{\frac{n+1}{2}}(\rho_{d3})^{\frac{n+3}{2}}(\rho_{d20}\rho_{d02}\rho_{d22})^{\frac{n+1}{2}}(t'')\nu_3^2.$$

To use the push forward theorem, we need to write each of these in terms of

$b$ -densities. First, we have on the center copy of  $\bar{Z}_h^2$

$${}^b\nu^2 = (\rho_{100}\rho_{010}\rho_{110}\rho_{220}\rho_{001}\rho_{d2})^{-1}\nu^2.$$

Then, we have

$${}^b\nu^2 = (\beta_c)_*(\beta_c)^*((\rho_{100}\rho_{010}\rho_{110}\rho_{220}\rho_{001}\rho_{d2})^{-1}\nu^2).$$

We observe

$$\begin{aligned} & (\beta_c)^*((\rho_{100}\rho_{010}\rho_{110}\rho_{220}\rho_{001}\rho_{d2})^{-1}) = \\ & (\rho_{10000}\rho_{00100}\rho_{11000}\rho_{01100}\rho_{10100}\rho_{11100}\rho_{22200}\rho_{02200}\rho_{20200}\rho_{d3}\rho_{d22}\rho_{00011})^{-1}. \end{aligned}$$

So now we multiply both sides of (2.8) by  $(\beta_c)_*(\beta_c)^*(\rho_{100}\rho_{010}\rho_{110}\rho_{220}\rho_{001}\rho_{d2})^{-1}$  and inside the right side of (2.8) we have

$$\begin{aligned} & (\rho_{11100}\rho_{11000}\rho_{01100}\rho_{10100})^{-\frac{1}{2}}(\rho_{22000}\rho_{02200}\rho_{22200})^{\frac{n}{2}}(\rho_{20200})^{\frac{n-2}{2}}, \\ & (\rho_{d3})^{\frac{n+1}{2}}(\rho_{d20}\rho_{d02})^{\frac{n+1}{2}}(\rho_{d22})^{\frac{n}{2}}(\rho_{10000}\rho_{00100})^{-1}\nu_3^2. \end{aligned}$$

To use the push forward theorem, we must change the density  $\nu_3^2$  to a  $b$ -density.

We observe

$$\begin{aligned} & {}^b\nu_3^2 = (\rho_{11100}\rho_{11000}\rho_{01100}\rho_{10100}\rho_{22200}\rho_{22000}\rho_{02200}\rho_{20200} \\ & \rho_{10000}\rho_{01000}\rho_{00100}\rho_{d3}\rho_{d20}\rho_{d02}\rho_{d22}\rho_{00011}\rho_{00010}\rho_{00001})^{-1}\nu_3^2. \end{aligned}$$

So, we now have for the composition formula

$$\begin{aligned} & (\beta_c)_*(\tilde{\kappa}_A\tilde{\kappa}_B(\rho_{11100}\rho_{11000}\rho_{01100}\rho_{10100})^{\frac{1}{2}}(\rho_{22200}\rho_{22000}\rho_{02200})^{\frac{n+2}{2}} \\ & (\rho_{20200})^{\frac{n}{2}}(\rho_{d3}\rho_{d20}\rho_{d02})^{\frac{n+3}{2}}(\rho_{d22})^{\frac{n+1}{2}}\rho_{01000}\rho_{00011}\rho_{00010}\rho_{00001}({}^b\nu_3^2)). \end{aligned}$$

We observe the following orders of  $\tilde{\kappa}_A$  on  $\bar{Z}_h^3$ .

Face	$\tilde{\kappa}_A$ Index Set/Leading Order
$F_{11100}$	$-\frac{1}{2} + A_{110}$
$F_{11000}$	$-\frac{1}{2} + A_{220}$
$F_{01100}, F_{10100}, F_{02200}, F_{20200}, F_{d22}$	$\infty$
$F_{22200}, F_{22000}$	$-\frac{n+2}{2} + A_{220}$
$F_{d3}, F_{d20}$	$-\frac{n+3}{2} - k_a$
$F_{10000}, F_{01000}, F_{00100}, F_{00010}, F_{00011}$	$\infty$

Similarly, for  $\tilde{\kappa}_B$  we have orders as follows.

Face	$\tilde{\kappa}_B$ Index Set/Leading Order
$F_{11100}$	$-\frac{1}{2} + B_{110}$
$F_{01100}$	$-\frac{1}{2} + B_{220}$
$F_{11000}, F_{10100}, F_{22000}, F_{20200}, F_{d22}$	$\infty$
$F_{22200}, F_{02200}$	$-\frac{n+2}{2} + B_{220}$
$F_{d3}, F_{d02}$	$-\frac{n+3}{2} - k_b$
$F_{10000}, F_{01000}, F_{00100}, F_{00010}, F_{00011}$	$\infty$

Now, recalling the formula:

$$(\beta_c)_*(\tilde{\kappa}_A \tilde{\kappa}_B (\rho_{11100} \rho_{11000} \rho_{01100} \rho_{10100})^{\frac{1}{2}} (\rho_{22200} \rho_{22000} \rho_{02200})^{\frac{n+2}{2}} (\rho_{20200})^{\frac{n}{2}} (\rho_{d3} \rho_{d20} \rho_{d02})^{\frac{n+3}{2}} (\rho_{d22})^{\frac{n+1}{2}} \rho_{01000} \rho_{00011} \rho_{00010} \rho_{00001} ({}^b \nu_3^2))$$

We see that the quantity on the right hand side to be pushed forward by  $(\beta_c)_*$  has the following indices on the boundary faces.

Face	Index Set/Leading Order
$F_{11100}$	$-\frac{1}{2} + A_{110} + B_{110}$
$F_{11000}, F_{01100}, F_{10100}, F_{22000}, F_{02200}, F_{20200}$	$\infty$
$F_{22200}$	$-\frac{n+2}{2} + A_{220} + B_{220}$
$F_{d3}$	$-\frac{n+3}{2} - (k_a + k_b)$
$F_{d20}, F_{d02}, F_{d22}$	$\infty$
$F_{10000}, F_{01000}, F_{00100}, F_{00010}, F_{00001}, F_{00011}$	$\infty$

The push forward under  $(\beta_c)^*$  sends the boundary faces of  $\bar{Z}_h^3$  to  $\bar{Z}_h^2$  as follows.

$\bar{Z}_h^3$ Face	Boundary face of $\bar{Z}_h^2$ or Interior
$F_{11100}$	$F_{110}$
$F_{10100}$	$F_{110}$
$F_{22200}, F_{20200}$	$F_{220}$
$F_{d3}, F_{d22}$	$F_{d2}$
$F_{10000}$	$F_{100}$
$F_{00100}$	$F_{010}$
$F_{00011}$	$F_{001}$
$F_{11000}, F_{01100}, F_{22000}, F_{02200},$	Interior
$F_{d20}, F_{d02}, F_{01000}, F_{00010}, F_{00001}$	Interior

The quantity to be pushed forward is integrable with respect to  ${}^b\nu_3^2$  at the faces that are mapped to the interior, so we may apply the push forward theorem (cf [21]) to arrive at the result of the composition rule. The kernel,  $\kappa_{B \circ A}$  will have the following polyhomogeneous index sets and leading orders on  $\bar{Z}_h^2$ .

Face of $\bar{Z}_h^2$	Index Set/Leading Order
$F_{110}$	$-\frac{1}{2} + A_{110} + B_{110}$
$F_{220}$	$-\frac{n+2}{2} + A_{220} + B_{220}$
$F_{d2}$	$-\frac{n+3}{2} - (k_a + k_b)$
$F_{100}$	$\infty$
$F_{010}$	$\infty$
$F_{001}$	$\infty$

This concludes the proof of the composition rule:  $B \circ A$  is an element of  $\Psi_{ac,H}^{A_{110}+B_{110}, A_{220}+B_{220}, k_a+k_b}$ .

♡

Now, we may give a precise description of the full heat kernel for the ac space.

**Theorem 2.16** *Let  $(Z, g_z)$  be an asymptotically conic manifold with cross section  $(Y, h)$  at infinity. Let  $(E, \nabla)$  be a Hermitian vector bundle over  $(Z, g_z)$  that retracts to a bundle over  $(Y, h)$ . Let  $\Delta$  be a geometric Laplacian on  $(Z, g_z)$  associated to the bundle  $(E, \nabla)$ . Then there exists  $H \in \Psi_{ac,H}^{E_{110}, E_{220}, -2}$  satisfying:*

$$(\partial_t + \Delta)H(z, z', t) = 0, t > 0,$$



$$H(z, z', 0) = \delta(z - z').$$

Moreover,  $H$  vanishes to infinite order at  $F_{110}$  and is smooth up to  $F_{220}$ .

The proof of this theorem is identical to that in the conic case; we begin with the first approximation, use Duhamel's principle and the composition formula to construct a parametrix up to infinite order. We then solve away the error obtaining the ac heat kernel whose leading orders on the boundary faces of the ac heat space are given by those of the first approximation.

♡

# Chapter 3

## Heat Kernel Convergence

### 3.1 Introduction

The preliminary result in the first chapter was convergence of the spectrum of the scalar Laplacian under asymptotically conic convergence. In this chapter we prove the main result: the asymptotic behavior under ac convergence of the heat kernels for the geometric Laplacians. We construct the asymptotically conic convergence (acc) heat space and acc heat calculus. The acc heat space contains as boundary faces and submanifolds the heat spaces studied in chapter two, while the acc heat calculus is constructed using the corresponding heat calculi from chapter two. We lift the heat operators  $\partial_t + \Delta_\epsilon$  to the acc heat space and construct the acc model heat kernel as an element of the acc heat calculus. The acc model heat kernel describes the asymptotic behavior of the heat kernels under ac convergence up to an error term of order  $O(\epsilon t^\infty)$  as  $\epsilon, t \rightarrow 0$ .

### 3.2 Preliminary Geometric Constructions

#### 3.2.1 The ACC Single Space Revisited

The construction of the acc single space here is equivalent to the definition in chapter one. The construction of the more complicated acc double space and acc heat

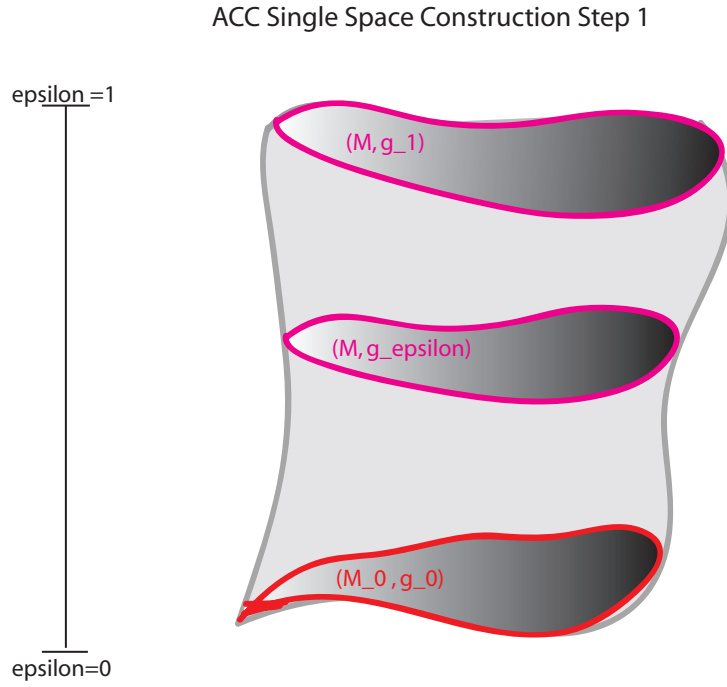

Figure 3.1: Construction of the acc single space:  $\mathcal{S}_\epsilon$

space are modeled after this construction of the single space as a compactification of  $M \times M \times (0, 1]_\epsilon$  using resolution blow ups.

Let

$$\mathcal{S}_0 = \bigcup_{\epsilon > 0} M_\epsilon \cup M_0^0,$$

where for each  $\epsilon > 0$ ,  $M_\epsilon$  is the resolution blow up of  $M_0$  by  $Z$  as in chapter one.  $\mathcal{S}_0$  is a smooth manifold with metric  $g_\epsilon$  on each fixed  $\epsilon$  slice induced by the metrics on  $M_0$  and  $Z$ . The completion with respect to the metric  $d\epsilon^2 + g_\epsilon$  is a singular space which we call  $\mathcal{S}_c$ , having one singular point  $P$  at  $\epsilon = 0$  at the cone point  $p \in M_0$ .

We write  $\mathcal{S}_c - \{P\}$  as a union of open sets,

$$\mathcal{S}_c - \{P\} = A \cup B,$$

where

$$A = \bigcup_{\epsilon > 0} M_{0,\epsilon} \quad \text{and} \quad B = \bigcup_{\epsilon > 0} Z_{1/\epsilon} \times \{\epsilon\}.$$

These sets overlap:

$$A \cap B = \bigcup_{\epsilon > 0} (Z_{1/\epsilon} - \bar{Z}_1).$$

The acc single space  $\mathcal{S}$  is the compactification of  $\mathcal{S}_c - \{P\}$  :

$$\mathcal{S} = \bar{Z} \times [0, 1]_{\tau} \cup_{\psi} (\mathcal{S}_c - \{P\})$$

where  $\psi$  is a patching map from  $\bar{Z} \times (0, 1) \rightarrow \mathcal{S}_0$  defined as follows.

First, we write  $\bar{Z}$  as an overlapping union of open sets,  $\bar{Z} = Z_2 \cup (\bar{Z} - \bar{Z}_1)$ , where  $Z_1$  and  $Z_2$  were defined above as  $Z_R$  for  $R = 1, 2$  respectively. For  $z \in Z_2$  and  $\tau \in (0, 1)$  define

$$\psi(z, \tau) = (z, \epsilon = \tau) \in \bigcup_{\epsilon > 0} M_{\epsilon} \times \{\epsilon\} \subset A.$$

For  $z \notin \bar{Z}_1$  and  $\tau \in (0, 1)$  we may write  $z = (x, y)$  with  $y \in Y$  and  $x = 1/\rho < 1$  for  $\rho > 1$ , then

$$\psi(x, y, \tau) = ((x\chi(x) + (1 - \chi(x))\tau, y, \tau x) = (r, y, \epsilon) \in \bigcup_{\epsilon > 0} M_{0,\epsilon} = B,$$

where  $\chi$  is a smooth cutoff function with

$$\chi(x) = \begin{cases} 1, & x \geq 1 \\ 0, & x < 1/2 \end{cases}$$

Note that  $x = 0$  defines the boundary  $Y$  of  $\bar{Z}$  and when  $x < 1/2$ ,  $r = \tau$  and  $\epsilon = \tau x$ . With this construction  $\mathcal{S}$  is a manifold with one corner of codimension two having two hypersurface boundary faces  $F_0 = M_0$  and  $F_1 = \bar{Z}$  that meet at the codimension two corner  $Y$ . The hypersurface boundary faces have defining functions  $\rho_0 = x$ ,  $\rho_1 = \tau$ . The radial distance  $r$  on  $M_0$  and the parameter  $\epsilon$  are

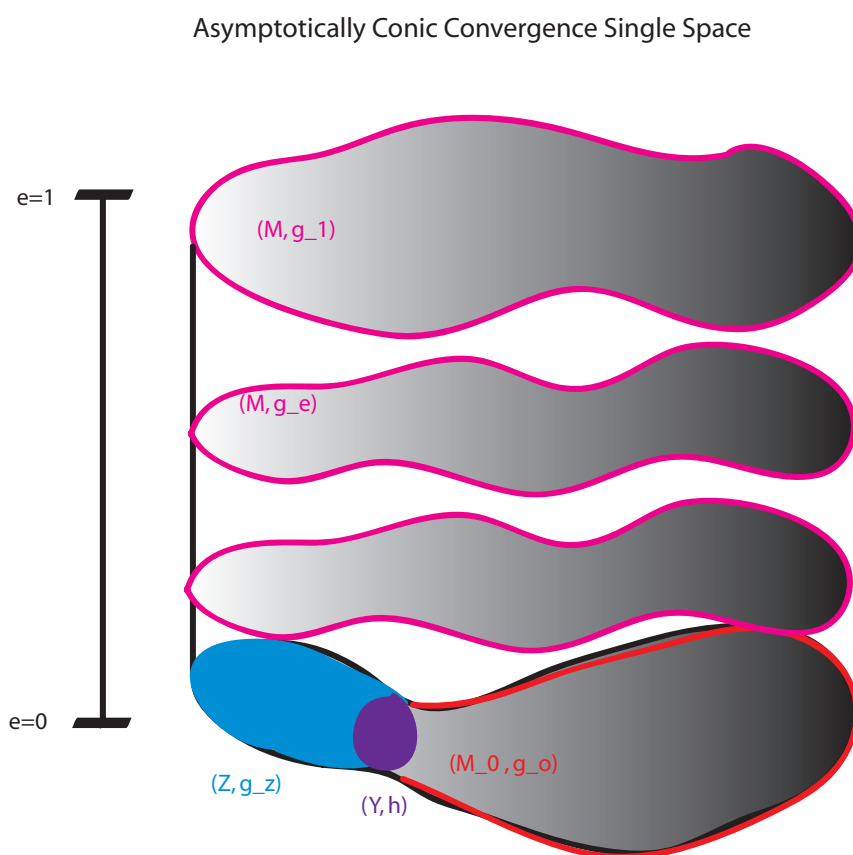

Figure 3.2: Acc single space

related by

$$r = \tau, \epsilon = \tau x.$$

For  $\tau > 0$ ,  $\psi$  is a diffeomorphism and in the region  $x < 1$ ,  $\psi$  is a standard radial blowdown map.

One of the key features of the acc single space is that it contains a submanifold diffeomorphic to a truncated cone over  $\bar{Z}$ . The map  $\psi$  identifies the interior of  $\bar{Z}$  with slices of  $\mathcal{S}$  at  $\epsilon > 0$ , and the boundary of  $\bar{Z}$  with slices of the  $F_0$  boundary face. In the conic submanifold  $\tau$  acts as the radial variable and  $F_1$  is the boundary of this submanifold at  $\tau = 0$ . The more complicated acc double space and acc heat space

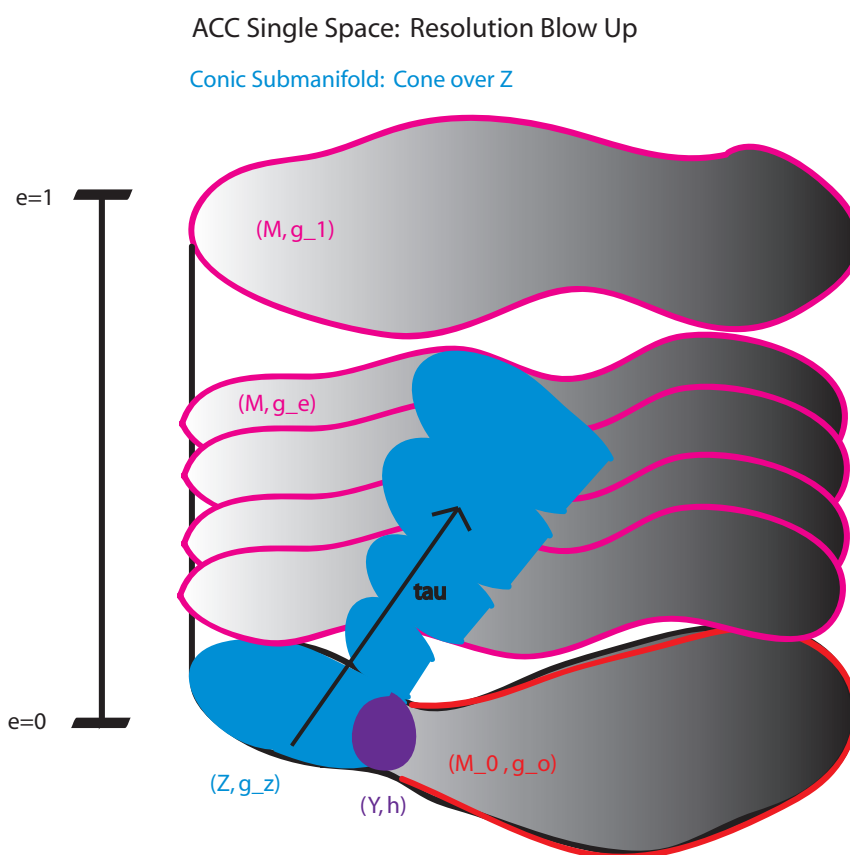

Figure 3.3: Acc single space: submanifold diffeomorphic to truncated cone over  $\bar{Z}$ .

are modeled after the single space and also contain submanifolds diffeomorphic to a truncated cone over a manifold with corners.

### 3.2.2 The ACC Double Space

We take

$$(M \times M \times (0, 1]_\epsilon) \cup (M_0 \times M_0 \times \{\epsilon = 0\})$$

and perform a resolution blow up at  $\epsilon = 0$  along the singular set in each copy of  $M_0$  and at the intersection of these. This is analogous to the resolution blow up

used to create the acc single space. The result is a manifold with four hypersurface boundary faces at  $\epsilon = 0$  called the acc double space  $\mathcal{D}$ . The boundary faces are described in the following table. Note that in the case  $\bar{Z}$  is a disk, these are standard radial blow ups with the first at the intersection of the singular sets and the next two at the single set in each copy of  $M_0$ .

Face	Geometry of Face	Defining Function
$F_1$	$\bar{Z}_b^2 = [\bar{Z} \times \bar{Z}; (\partial\bar{Z} \times \partial\bar{Z})]$	$\rho_1$
$F_0$	$M_b^2 = [M_0 \times M_0; \{x = 0, x' = 0\}]$	$\rho_0$
$F_{10}$	$\bar{Z} \times M_0$	$\rho_{10}$
$F_{01}$	$M_0 \times \bar{Z}$	$\rho_{01}$

The edges of these boundary faces meet in corners described in the following table. Below  $SN^+(X)$  is the inward pointing spherical normal bundle of  $X$ .

Corner	Geometry of Corner	Defining Function	Contained in Faces
$C_{111}$	$N^+(Y \times Y)$	$\rho_{111}$	$F_1$ and $F_0$
$C_{110}$	$Y \times \bar{Z}$	$\rho_{110}$	$F_1$ and $F_{01}$
$C_{101}$	$\bar{Z} \times Y$	$\rho_{101}$	$F_1$ and $F_{10}$
$C_{001}$	$M_0 \times Y$	$\rho_{001}$	$F_0$ and $F_{01}$
$C_{010}$	$Y \times M_0$	$\rho_{010}$	$F_0$ and $F_{10}$

In figure 3.4,  $F_1$  looks like an igloo attached to tubes  $F_{01}$  and  $F_{10}$  above  $F_0$ . The boundary faces are color coded. In the picture there appear to be four distinct  $F_0$  but this is a dimensional artifact.

Like the single space, the double space contains a submanifold diffeomorphic to a truncated cone over a manifold with corners. In this case, the link of the cone is  $\bar{Z}_b^2$ , the  $b$ -blow up of  $\bar{Z}$ . Recall the  $b$ -blow up of  $\bar{Z}$ ,

$$\bar{Z}_b^2 = [\bar{Z} \times \bar{Z}; (\partial\bar{Z}) \times (\partial\bar{Z})].$$

Boundary face of $\bar{Z}_b^2$	Geometry of Face
$Z_{11}$	$SN^+(Y \times Y)$
$Z_{10}$	$Y \times \bar{Z}$
$Z_{01}$	$\bar{Z} \times Y$

The acc double space contains for each  $\epsilon > 0$  a submanifold diffeomorphic to

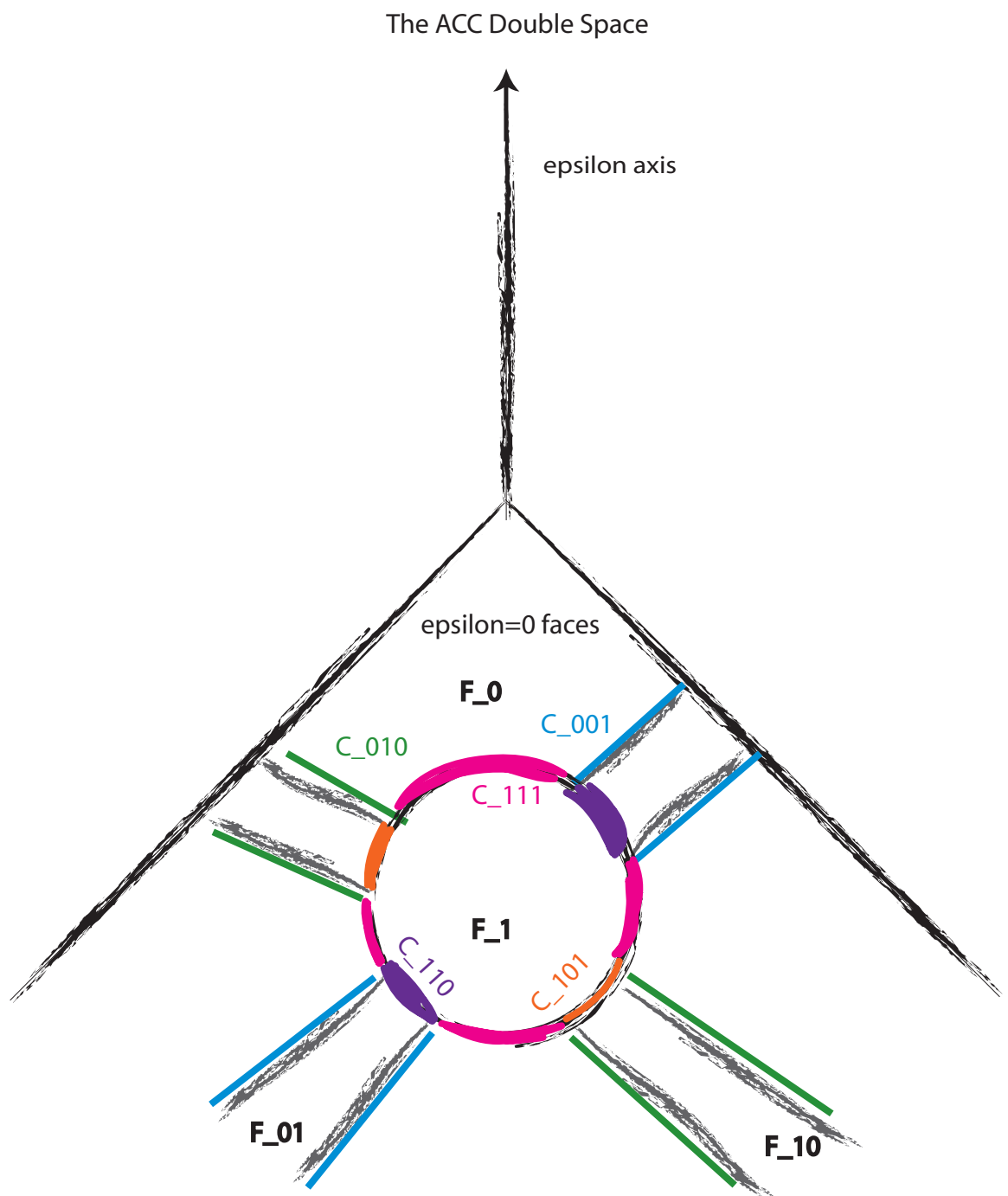

Figure 3.4: The acc double space.



the interior of  $Z \times Z$  in  $M \times M \times \{\epsilon\}$ . The interior of the link of the cone lies in the region of  $\mathcal{D}$  with  $\epsilon > 0$ . The boundary faces of the link of the cone are contained in  $F_0$  near the corners of this face. The  $Z_{11}$  boundary of  $\bar{Z}_b^2$  lies in a neighborhood at  $\epsilon = 0$  of the  $C_{111}$  corner. The  $Z_{10}$  and  $Z_{01}$  boundary faces of  $\bar{Z}_b^2$  lie respectively in  $F_0$  in a neighborhood of the  $C_{110}$  and  $C_{101}$  corners.

Due to the different geometries there are no global coordinates on  $\mathcal{D}$ . Instead we consider local coordinates in different regions of  $\mathcal{D}$ . For each  $(M, g_\epsilon)$  we may in a neighborhood  $V \subset U$  define the coordinate  $x = \epsilon/(\phi_\epsilon^{-1})^*r$  where  $r = 0$  defines the boundary of  $\bar{Z}$ . Note that these coordinates are only valid on the neighborhood  $V$  and that in this neighborhood,  $\epsilon < x < x_1$ . These coordinates induce local coordinates  $(x, y, x', y', \epsilon)$  on a neighborhood in  $\mathcal{D}$ . From these we define the following projective coordinates

$$(s, y, s', y', \eta) : \quad s = \frac{x}{x'}, \quad s' = x', \quad \eta = \frac{\epsilon}{x'}.$$

These coordinates are valid away from  $F_{01}$ . In these coordinates,  $\eta = 0$  at  $F_0$  and  $F_{10}$ .  $F_1$  is defined by  $s' = 0$ . It will be useful to express the geometric Laplacians for  $(M, g_\epsilon)$ ,  $(Z, g_Z)$ , and  $(M_0, g_0)$  in these projective coordinates. We denote these geometric Laplacians respectively by  $\Delta_\epsilon$ ,  $\Delta_Z$ , and  $\Delta_0$ . In projective coordinates,

$$\Delta_\epsilon = (s')^{-2}(\partial_s^2 + s^{-2}(\Delta_y + lot)).$$

Here, we have used  $\Delta_y$  to denote the induced geometric Laplacian on  $(Y, h)$  and  $lot$  for lower order terms. Similarly, we have

$$\Delta_Z = (\eta)^2(\partial_s^2 + s^{-2}(\Delta_y + lot)) = \epsilon^2(s')^{-2}(\partial_s^2 + s^{-2}(\Delta_y + lot)).$$

Finally, for the conic Laplacian we have

$$\Delta_0 = (s')^{-2}(\partial_s^2 + s^{-2}(\Delta_y + lot)).$$

These calculations and the construction of the acc double space will be helpful in understanding the acc heat space, which we now introduce.

### 3.3 The Asymptotically Conic Convergence (ACC) Heat Space

Analogous to the acc single and double spaces, the acc heat space is a compactification of  $M \times M \times \mathbb{R}^+ \times (0, 1]_\epsilon$  as a manifold with corners. We take

$$(M \times M \times \mathbb{R}^+ \times (0, 1]_\epsilon) \cup (M_0 \times M_0 \times \mathbb{R}^+ \times \{\epsilon = 0\})$$

and perform a resolution blow up along the singular set in each copy of  $M_0$  and at the intersection of these at  $t = 0$ , where the  $t$  direction is parabolically blown up. This is analogous to the resolution blow up in the acc double space construction. This creates the faces  $F_{11} \cong PN^+(\bar{Z} \times \bar{Z})$ ,  $F_{01} \cong M_0 \times \bar{Z}$ , and  $F_{10} \cong \bar{Z} \times M_0$ . We next perform standard radial and parabolic blow ups. Inside  $F_{11} = PN^+(\bar{Z} \times \bar{Z})$  we perform a standard radial blow up at the codimension two corner  $\partial\bar{Z} \times \partial\bar{Z}$  creating the corner  $C_{1111} \cong SN^+(Y \times Y)$ . Next, we blow up the diagonal in  $F_{11}$ . Let  $\sigma = t/(\epsilon^2)$ . We blow up the diagonal in  $Z \times Z$  at  $\sigma = 0$  parabolically in the  $\sigma$  direction. The resulting corner we call  $C_{1d2}$  and is diffeomorphic to the parabolic normal bundle of the diagonal in  $Z \times Z$ .

For each  $\epsilon > 0$ , we blow up  $t$  parabolically the diagonal in  $M \times M \times \mathbb{R}_t^+$ . The corners created by these blow ups are  $C_{\epsilon d2}$ . Finally, at  $\epsilon = 0$  we blow up  $t$  parabolically the diagonal at  $t = 0$  away from the previously blown up faces. This final blow up creates the corner  $C_{0d2}$  which is diffeomorphic to the parabolic normal bundle of the diagonal in  $M_0 \times M_0$  and completes our construction of the acc heat space.

The boundary faces of the acc heat space are described in the following table.  $\Delta(X)$  is the diagonal in  $X \times X$ .  $\bar{Z}_{b,h}^2$  is the  $b$ -heat space of  $\bar{Z}$ ,  $M_{0,h}^2$  is the conic heat space for  $M_0$ , and  $M_{\epsilon,h}^2$  is the heat space for  $(M, g_\epsilon)$ . The first four boundary faces occur at  $\epsilon = 0$ , while the last two occur at  $t = 0$ . The face  $F_{001}$  is the acc double space in which the diagonal has been blown up  $t$ -parabolically.

Face	Geometry of Face	Defining Function
$F_{11}$	$\bar{Z}_{b,h}^2$	$\rho_{11}$
$F_{00}$	$M_{0,h}^2$	$\rho_{00}$
$F_{10}$	$\bar{Z} \times M_0 \times \mathbb{R}^+$	$\rho_{10}$
$F_{01}$	$M_0 \times \bar{Z} \times \mathbb{R}^+$	$\rho_{01}$
$F_{001}$	$\mathcal{D} - \Delta(\mathcal{D}) \cup PN^+(\Delta(\mathcal{D}))$	$\rho_{001}$
$F_\epsilon$	$M_{\epsilon,h}^2$	$\rho_\epsilon$

The boundary faces of the acc heat space meet in corners described in the following table. We use  $X_b^2$  to denote the  $b$ -blowup of  $X$ .

Corner	Geometry of Corner	Contained in $\mathcal{H}$ boundary faces
$C_{1110}$	$PN^+(Y \times Y)$	$F_{11}, F_{00}, F_{001}$
$C_{1111}$	$\bar{Z}_b^2 - \Delta(Z)$	$F_{11}, F_{001}$
$C_{1d2}$	$PN^+(\Delta(Z))$	$F_{11}, F_{001}$
$C_{1101}$	$Z \times Y \times \mathbb{R}_\sigma^+$	$F_{11}, F_{01}, F_{001}$
$C_{1110}$	$Y \times Z \times \mathbb{R}_\sigma^+$	$F_{11}, F_{10}, F_{001}$
$C_{0010}$	$Y \times M_0 \times \mathbb{R}_t^+$	$F_{00}, F_{10}$
$C_{0001}$	$M_0 \times Y \times \mathbb{R}_t^+$	$F_{00}, F_{01}$
$C_{0d2}$	$PN^+(\Delta(M_0))$	$F_{00}, F_{001}$
$C_{001}$	$(M_0)_b^2 - \Delta(M_0)$	$F_{00}, F_{001}$
$C_{\epsilon d2}$	$PN^+(\Delta(M))$	$F_\epsilon, F_{001}$
$C_{\epsilon 1}$	$M \times M - \Delta(M)$	$F_\epsilon, F_{001}$

As with the acc single and double spaces, the acc heat space contains a submanifold diffeomorphic to the truncated cone over a manifold with corners; in this case the link of the cone is  $\bar{Z}_{b,h}^2$ . The conic submanifold of  $\mathcal{H}$  has radial variable  $\rho = \rho_{11}$ , the defining function for  $F_{11}$ , the boundary of the conic submanifold. Note that  $\epsilon$  lifts to the acc heat space via

$$\beta^* : M \times M \times \mathbb{R}^+ \times (0, 1]_\epsilon \cup M_0 \times M_0 \times \mathbb{R}^+ \times \{\epsilon = 0\}$$

as

$$\beta^* \epsilon = \rho_{11} \rho_{00} \rho_{10} \rho_{01}.$$

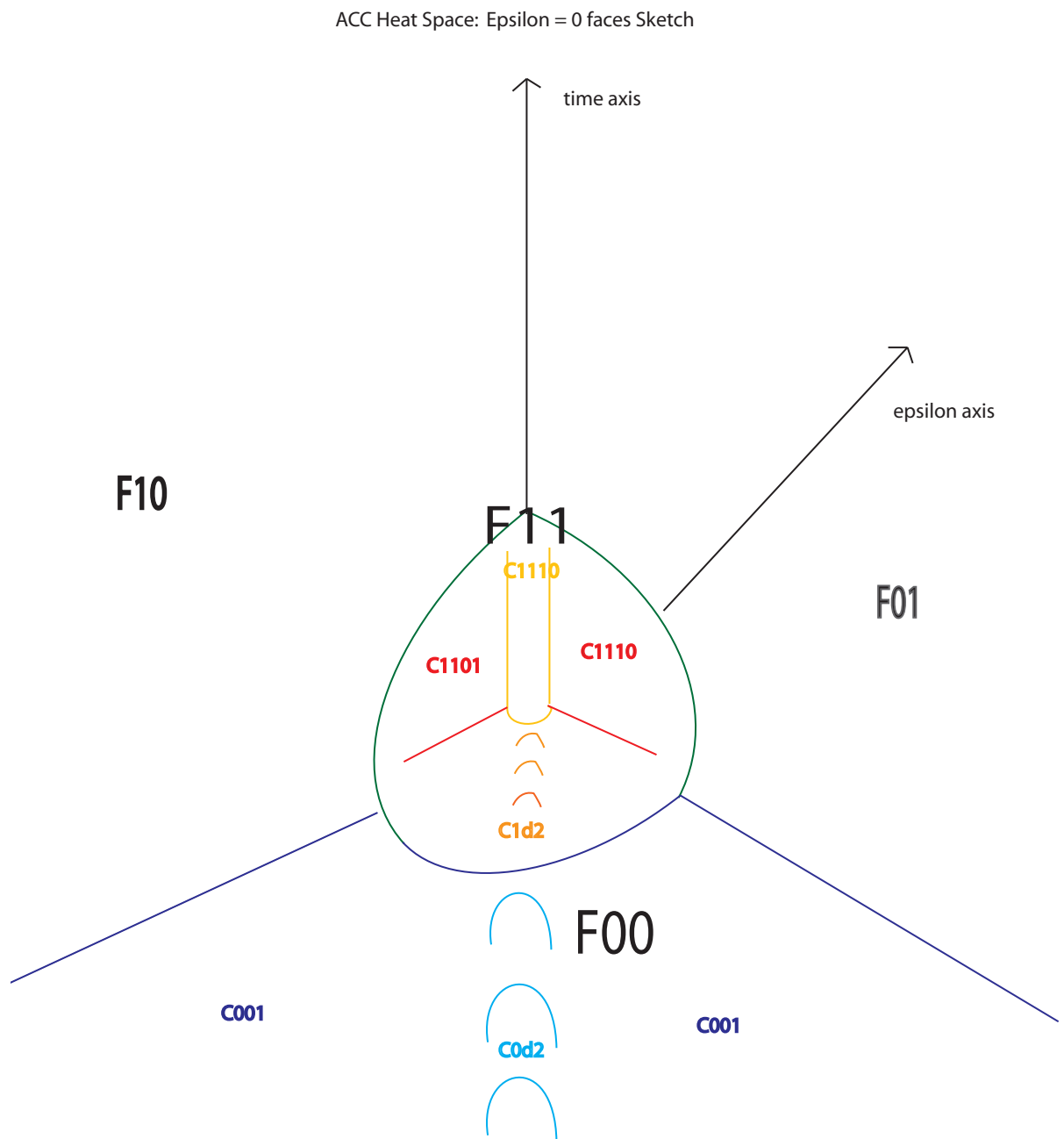

Figure 3.5: Schematic diagram of acc heat space  $\epsilon = 0$  faces and corners.

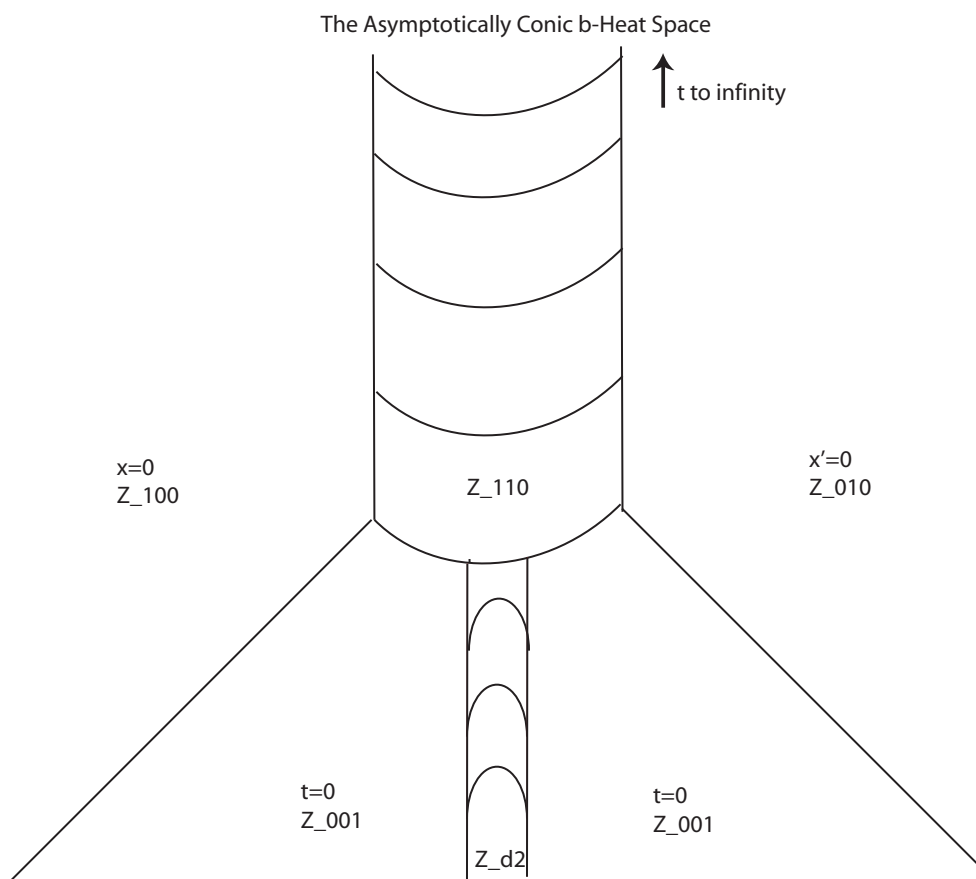

Figure 3.6: The ac  $b$ -heat space,  $\bar{Z}_{b,h}^2$ .

So  $\epsilon$  is not a defining function for any of these faces in the acc heat space. The interior of the link of the cone is at  $\epsilon > 0$ , while the boundary faces of the link of the cone each correspond to a corner in  $F_{00}$ .  $\bar{Z}_{b,h}^2$  has five boundary faces described below with the corresponding  $F_{00}$  corners.

Boundary face of $\bar{Z}_{b,h}^2$	Geometry of face	Corresponding $\mathcal{H}$ corner in $F_{00}$
$Z_{110}$	$N^+(Y \times Y) \times \mathbb{R}^+$	$C_{1110}$
$Z_{100}$	$Y \times Z \times \mathbb{R}^+$	$C_{0010}$
$Z_{010}$	$Z \times Y \times \mathbb{R}^+$	$C_{0001}$
$Z_{001}$	$Z \times Z - \Delta(Z)$	$C_{001}$
$Z_{d2}$	$PN^+(\Delta(Z))$	$C_{0d2}$

We are now equipped to introduce the acc heat calculus, a parameter dependent heat operator calculus defined on the acc heat space.

### 3.4 The ACC Heat Calculus

The acc heat calculus incorporates the heat operator calculi studied in chapter two. Let  $\Psi_{\epsilon,H}^k$  be the heat calculus of order  $k$  for the smooth compact manifold  $(M, g_\epsilon)$ . As defined in chapter two,  $\Psi_{b,H}^{k,E_{110}}$  is the  $b$ -heat calculus of order  $k$  consisting of Schwartz kernels with index set  $E_{110}$  at  $F_{110}$ , and  $\Psi_{0,H}^{k,E_{112},E_{100},E_{010}}$  is the conic heat calculus of order  $k$  consisting of kernels with index sets  $E_{112}$ ,  $E_{100}$ ,  $E_{010}$  at  $F_{112}$ ,  $F_{100}$ ,  $F_{010}$ , respectively. The acc heat calculus consists of kernels that restrict on each  $\epsilon$  slice of  $\mathcal{H}$  to an element of  $\Psi_{\epsilon,H}^k$  and which have an expansion at the  $\epsilon = 0$  faces of  $\mathcal{H}$  in terms of elements of  $\Psi_{b,H}^{k,E_{110}}$  and  $\Psi_{0,H}^{k,E_{112},E_{100},E_{010}}$ .

**Definition 3.5** *The asymptotically conic convergence heat calculus of order  $k$ , written  $\Psi_{acc,H}^{k,E_{11},E_{00},E_{10},E_{01}}$  consists of kernels  $A$  such that the following hold.*

1. For each  $\epsilon > 0$   $A$  restricts to an element of  $\Psi_{\epsilon,h}^k$ .
2. In a neighborhood of  $F_{11}$ ,  $A$  has an asymptotic expansion in  $\rho_{11}$  with index set  $E_{11}$  such that the coefficients are elements of the  $b$ -heat calculus of order

*k.* Such an expansion is of the form

$$A \sim \sum_{j \geq 1} \sum_{p_0 \leq p \leq p_j} (\rho_{11})^{\alpha_j} (\log \rho_{11})^p A_j,$$

with  $A_j \in \Psi_{b,H}^{k,E_{11}^j}$ . Above, if for some  $j$  there are no log terms then  $p_0 = p_j = 0$ .

3. In a neighborhood of  $F_{00}$ ,  $A$  has an asymptotic expansion in  $\rho_{00}$  with index set  $E_{00}$  such that the coefficients are elements of the conic heat calculus of order  $k$ . Such an expansion is of the form

$$A \sim \sum_{l \geq 1} \sum_{p_0 \leq p \leq p_l} (\rho_{00})^{\alpha_l} (\log \rho_{00})^p B_l,$$

with  $B_l \in \Psi_{0,H}^{k,E_{11}^l, E_{100}^l, E_{010}^l}$ .

4.  $A$  has asymptotic expansion in  $\rho_{10}$  at  $F_{10}$  with index set  $E_{10}$  and asymptotic expansion in  $\rho_{01}$  at  $F_{01}$  with index set  $E_{01}$ .

We next state the expected composition rule for this calculus.

**Conjecture 3.6** *Let  $A$  be an element of  $\Psi_{acc,H}^{k_a, A_{11}, A_{00}, A_{10}, A_{01}}$  and  $B$  be an element of  $\Psi_{acc,H}^{k_b, B_{11}, B_{00}, B_{10}, B_{01}}$ . Then the composition  $A \circ B$  is an element of  $\Psi_{acc,H}^{k, E_{11}, E_{00}, E_{10}, E_{01}}$  with the following index sets and leading orders.*

$$k = k_a + k_b,$$

$$E_{11} = A_{11} + B_{11}, \quad E_{00} = A_{00} + B_{00},$$

$$E_{10} = A_{10} + B_{10}, \quad E_{01} = A_{01} + B_{01}.$$

### Leading Orders Calculation

We use the composition rule on each of the heat calculi. For each  $\epsilon > 0$ , the restrictions of  $A$  and  $B$  to the  $\epsilon$  slice of  $\mathcal{H}$  compose to give

$$(A \circ B)|_\epsilon \in \Psi_{\epsilon, H}^{k_a+k_b}.$$

At the  $\epsilon = 0$  faces, we have the following.

At  $F_{11}$ ,  $A$  is of the form

$$A \sim \sum_{j \geq 1} \sum_{p_0 \leq p \leq p_j} (\rho_{11})^{\alpha_j} (\log \rho_{11})^p A_j,$$

with  $A_j \in \Psi_{b, H}^{k_a, A_{110}^j}$  and  $\{\alpha_j, p_j\} = A_{11}$ . Similarly,  $B$  is of the form

$$B \sim \sum_{l \geq 1} \sum_{p_0 \leq q \leq p_l} (\rho_{11})^{\beta_l} (\log \rho_{11})^q B_l,$$

with  $B_l \in \Psi_{b, H}^{k_b, B_{110}^l}$  and  $\{\beta_l, q_l\} = B_{11}$ . At this face the composition  $A \circ B$  has the form

$$A \circ B \sim \sum_{m \geq 1} \sum_{j+l=m} \sum_{r_0 \leq r \leq r_m} (\rho_{11})^{\alpha_j+\beta_l} (\log(\rho_{11}))^r A_j \circ B_l.$$

By the composition rule for the  $b$ -heat calculus,  $A_j \circ B_l$  is an element of  $\Psi_{b, H}^{k_a+k_b, A_{110}^j+B_{110}^l}$ .

This shows that the composition  $A \circ B$  has expansion of the form

$$A \circ B \sim \sum_{m \geq 1} \sum_{p_0 \leq r \leq r_m} (\rho_{11})^{\gamma_m} (\log(\rho_{11}))^r C_m$$

with index set  $\{\gamma_m, r_m\} = A_{11} + B_{11}$  and  $C_m$  is an element of the  $b$ -heat calculus of order  $k_a + k_b$ .

At the  $F_{00}$ ,  $A$  has an expansion of the form

$$A \sim \sum_{j \geq 1} \sum_{r_0 \leq r \leq r_j} (\rho_{00})^{a_j} (\log(\rho_{00}))^r R_j$$



with index set  $\{a_j, r_j\} = A_{00}$  and  $R_j$  is an element of  $\Psi_{0,H}^{k_a, A_{112}^j, A_{100}^j, A_{010}^j}$ . Similarly, at  $F_{00}$ ,  $B$  has an expansion of the form

$$B \sim \sum_{l \geq 1} \sum_{s_0 \leq s \leq s_l} (\rho_{00})^{b_l} (\log(\rho_{00}))^s S_l$$

with index set  $\{b_l, s_l\} = B_{00}$  and  $S_l$  is an element of  $\Psi_{0,H}^{k_b, B_{112}^l, B_{100}^l, B_{010}^l}$ . The composition  $A \circ B$  then has an expansion at  $F_{00}$  as follows

$$A \circ B \sim \sum_{m \geq 1} \sum_{j+l=m} \sum_{p_0 \leq p \leq p_j} (\rho_{00})^{a_j+b_l} (\log(\rho_{00}))^p R_j \circ S_l.$$

By the composition rule for the conic heat calculus,  $R_j \circ S_l$  is an element of the conic heat calculus,  $R_j \circ S_l \in \Psi_{0,H}^{k_a+k_b, A_{112}^j+B_{112}^l, A_{110}^j+B_{110}^l, A_{100}^j+B_{100}^l, A_{010}^j+B_{010}^l}$ . This shows that the composition  $A \circ B$  has an expansion of the form

$$A \circ B \sim \sum_{m \geq 1} \sum_{p_0 \leq p \leq p_m} (\rho_{00})^{c_m} (\log(\rho_{00}))^p G_m$$

with index set  $\{c_m, p_m\} = A_{00} + B_{00}$  and  $G_m$  is an element of the conic heat calculus of order  $k_a + k_b$ .

Finally, at the  $F_{10}$  face  $A$  and  $B$  have expansions with index sets  $A_{10}$  and  $B_{10}$ , respectively. The composition then has an expansion up to  $F_{10}$  with index set  $A_{10} + B_{10}$ . Similarly, at  $F_{01}$  the composition has index set given by the sum of those of  $A$  and  $B$  at this face, namely,  $A_{01} + B_{01}$ .

### 3.7 ACC Heat Kernel Convergence

**Main Theorem: ACC Heat Kernel Convergence 3.8** *Let  $(M, g_\epsilon)$  be a family of smooth compact Riemannian  $n$  manifolds,  $(M_0, g_0)$  be a compact  $n$  manifold with isolated conic singularity and  $(Z, g_z)$  be an asymptotically conic space of dimension  $n$ . Assume that  $(M, g_\epsilon)$  converges asymptotically conically to  $(M_0, g_0)$ ,  $(Z, g_z)$ . Let  $(E, \nabla)$  be a Hermitian vector bundle over  $(M, g_\epsilon)$  for each  $\epsilon$ . Note that by the definition of ac convergence, specifically by the structure of the acc single*

space, this induces bundles over  $(Z, g_z)$  and  $(M_0, g_0)$ . Assume that the induced bundle over  $(M_0, g_0)$  retracts onto a bundle over the cross section  $(Y, h)$ . Associated to the bundle  $(E, \nabla)$  let  $\Delta_\epsilon$ ,  $\Delta_0$ , and  $\Delta_Z$  be geometric Laplacians on  $(M, g_\epsilon)$ ,  $(M_0, g_0)$  and  $(Z, g_z)$ , respectively. Assume that each of these operators is of the form

$$\nabla^* \nabla + \mathcal{R},$$

with  $\mathcal{R}$  a positive self adjoint endomorphism of  $E$ .

Then the heat kernels  $H_\epsilon$  have the following asymptotic behavior on the acc heat space as  $\epsilon \rightarrow 0$ .

$$H_\epsilon(z, z', t) \rightarrow H_0(z, z', t') + O(\epsilon t^N) \text{ at } F_{00} \forall N > 0$$

$$H_\epsilon(z, z', t) \rightarrow (\rho_{11})^2 H_b(z, z', \tau) + O(\epsilon t^N) \text{ at } F_{11} \forall N > 0,$$

$$H_\epsilon \text{ has leading order } (\rho_{10})^2, (\rho_{01})^2 \text{ at } F_{10}, F_{01}, \text{ respectively.}$$

In the above,  $H_0$  is the heat kernel for  $\Delta_0$ ,  $H_b$  is the b-heat kernel associated to  $\Delta_z$  and  $t'$  and  $\tau$  are rescaled time variables with

$$t' = \frac{t}{(\rho_{11})^2}, \quad \tau = \frac{t}{(\rho_{10}\rho_{01})^2}.$$

Moreover, the error term in this approximation,  $E(z, z', t, \epsilon)$  is  $O(\epsilon t^\infty)$  as  $\epsilon \rightarrow 0$ ,  $t \rightarrow \infty$ .

### Proof

The first step is to determine the leading orders as  $\epsilon \rightarrow 0$  of  $\partial_t + \Delta_\epsilon$  lifted to the acc heat space. We also require that  $\partial_t + \Delta_\epsilon$  restricts to  $\partial_t + \Delta_z$  on  $F_{11}$  and to  $\partial_t + \Delta_0$  on  $F_{00}$ .

First we compute  $\partial_t + \Delta_\epsilon$  in the local coordinates  $(x, y, x', y', t, \epsilon)$  for  $\epsilon > 0$ ,

$$\Delta_\epsilon = (\partial_x^2 + x^{-2}(\Delta_y + lot)).$$

In projective coordinates this becomes

$$\Delta_\epsilon = (s')^{-2}(\partial_s^2 + s^{-2}(\Delta_y + lot)).$$

hence

$$\partial_t + \Delta_\epsilon = \partial_t + (s')^{-2}(\Delta_{0,s}) = (s')^{-2}(\partial_{t'} + \Delta_{0,s}),$$

where  $t' = \frac{t}{(x')^2}$  and  $\Delta_{0,s}$  is a conic Laplacian in the coordinates  $(s, y)$ . Because  $s'$  is a defining function for  $F_{11}$ , this calculation shows that  $\partial_t + \Delta_\epsilon$  has leading order  $\rho_{11}^{-2}$  at  $F_{11}$ . It also shows the leading term of  $\partial_t + \Delta_\epsilon$  at  $F_{00}$  is

$$(\rho_{11})^{-2}(\partial_{t'} + \Delta_{0,s}).$$

The use of rescaled time variables is a result of the compactification of  $M_{0,h}^2$ .

Next, we compute leading orders near  $F_{11}$ . Define the rescaled time variable,  $\tau = \frac{t}{\eta^2}$ . On  $F_{11}$  we have the coordinates

$$(s, y, \eta, y', \tau),$$

where  $s, y, \eta, y'$  are the same projective coordinates as above. Note that  $\eta = \frac{\epsilon}{x'} = r'$  on  $F_{11}$ . In the local coordinates  $(r, y, r', y', t, \epsilon)$

$$\partial_t + \Delta_Z = \partial_t + r^2((r\partial_r)^2 + \Delta_y + lot),$$

where  $\Delta_y$  is the geometric Laplacian induced by  $\Delta_Z$  on the cross section  $(Y, h)$  and  $lot$  are lower order terms. Then, with respect to the projective coordinates

$$\partial_t + \Delta_Z = \left(\frac{\eta}{s}\right)^2 (\partial_\tau + \Delta_{b,s})$$

where  $\Delta_b = ((s\partial_s)^2 + \Delta_y + lot)$ . Since we require  $\partial_t + \Delta_\epsilon$  to restrict to  $\partial_t + \Delta_z$  on  $F_{11}$  and because  $\frac{s}{\eta}$  is a boundary defining function for  $F_{10}$ , by symmetry (which follows because we are working with Friedrich's extensions)  $\partial_t + \Delta_\epsilon$  has leading order  $-2$  at  $F_{10}$  and  $F_{01}$ . These calculations are summarized in the following table.

$\mathcal{H}$ Boundary Face/Region	$\partial_t + \Delta_\epsilon$	Time Variable
$F_{11}$	$(\rho_{10}\rho_{01})^{-2}(\partial_\tau + \Delta_{b,s})$	$\tau = \frac{t}{(\rho_{10}\rho_{01})^2}$
$\epsilon > 0$	$(\rho_{11})^{-2}(\partial_{t'} + \Delta_{0,s})$	$t' = \frac{t}{(\rho_{11})^2}$
$F_{00}$	$(\rho_{11})^{-2}(\partial_{t'} + \Delta_{0,s})$	$t' = \frac{t}{(\rho_{11})^2}$

We now have the leading order terms of  $\partial_t + \Delta_\epsilon$  at the  $\epsilon = 0$  boundary faces of  $\mathcal{H}$  and construct the acc model heat kernel  $H_1$  to be an element of the acc heat calculus that solves the heat equation at the boundary faces (and interior) of  $\mathcal{H}$  to at least first order.

### The ACC Model Heat Kernel

At the  $F_{00}$ , let  $H_1$  have expansion

$$H_1 \sim H_0(z, z', t'),$$

where  $H_0$  is the heat kernel constructed in chapter two for the conic manifold  $(M_0, g_0)$  and  $t'$  is the rescaled time variable

$$t' = \frac{t}{(\rho_{11})^2}.$$

At the  $F_{11}$ , let  $H_1$  have expansion

$$H_1 \sim (\rho_{11})^2 H_b(z, z', \tau),$$

where  $H_b$  is the  $b$  heat kernel constructed in chapter two and  $\tau$  is the rescaled time variable

$$\tau = \frac{t}{(\rho_{10}\rho_{01})^2}.$$

Finally, let  $H_1$  have expansions up to  $F_{10}$  and  $F_{01}$  with leading terms

$$(\rho_{10})^2, (\rho_{01})^2,$$

where the remaining terms in the expansion are determined by  $H_1|_{F_{11}}$  and  $H_1|_{F_{00}}$ . Extend  $H_1$  smoothly off these boundary faces so that for  $\epsilon > \epsilon_0 > 0$ ,  $H_1$  is the

heat kernel for  $(M, g_\epsilon)$ . As  $t \rightarrow 0$  away from the corners of  $\mathcal{H}$  we require that  $H_1$  vanishes to infinite order. At the diagonal where  $t = 0$ , namely  $C_{0d2}$ ,  $C_{1d2}$  and  $C_{\epsilon d2}$  away from the corners of these faces a local construction with the Euclidean heat kernel solves the heat equation up to  $O(t)$  and similar to the standard heat parametrix construction this can be improved to solve to infinite order in  $t$  as  $t \rightarrow 0$  uniformly down to  $\epsilon = 0$ . Let  $E(z, z', t, \epsilon) = H_\epsilon(z, z', t) - H_1(z, z', t, \epsilon)$ . Let  $K$  be defined for each  $\epsilon > 0$  by

$$(\partial_t + \Delta_\epsilon)E(z, z', t, \epsilon) = K(z, z', t, \epsilon).$$

The way we have defined  $H_1$ ,  $K = O(\epsilon t)$  as  $\epsilon, t \rightarrow 0$ . Moreover, a local construction similar to the standard heat parametrix construction improves this a priori  $O(\epsilon t)$  error to  $O(\epsilon t^\infty)$ . This means that for any  $N \in \mathbb{N}$ , there is  $C > 0$  such that for any  $(z, z') \in M \times M$ ,  $|K(z, z', t, \epsilon)| < C\epsilon t^N$ .

For each  $\epsilon > 0$   $E$  is smooth on  $\mathcal{H}$  for  $t, \epsilon > 0$  by parabolic regularity, applied for each  $\epsilon > 0$ , since  $K$  is  $O(t^\infty)$ . By construction  $E$  is smooth down to  $t = 0$ , so  $E(z, z', t, \epsilon)$  is smooth on the blown down space,  $M \times M \times \mathbb{R}^+ \times (0, 1]_\epsilon$ . We can now use a maximum principle argument on  $M \times [0, T]_t$  that will show that  $E$  is also  $O(\epsilon t^\infty)$  as  $\epsilon, t \rightarrow 0$  in the same sense as  $K$ .

Fix  $\epsilon > 0$ ,  $z' \in M$ . Since  $K = O(\epsilon t^\infty)$ , fix  $C > 1$  and  $N \ni N \gg 1$  such that  $|K(z, z', t, \epsilon)|^2 \leq C\epsilon^2 t^{2N}$  for all  $z \in M$ . Let  $u(z, t) = |E(z, z', t, \epsilon)|^2$ . Let  $\Delta$  be the scalar Laplacian for  $(M, g_\epsilon)$ . Then  $u$  satisfies

$$\begin{aligned} (\partial_t + \Delta)u &= 2\langle (\partial_t + \nabla^* \nabla)E, E \rangle - |\nabla E|^2 = 2\langle K - \mathcal{R}E, E \rangle - |\nabla E|^2 \\ &\leq 2\langle K, E \rangle \leq 2|K||E| \leq |K|^2 + |E|^2 = |K|^2 + u. \end{aligned}$$

Above we have used the positivity of  $\mathcal{R}$  and the compatibility of the bundle connection with the metric. Now, let  $\tilde{u} = e^{-t}u$ . Then  $\tilde{u}$  satisfies

$$(\partial_t + \Delta)\tilde{u} \leq e^{-t}|K|^2 \leq C\epsilon^2 t^{2N}.$$

Let  $w = \tilde{u} - C\epsilon^2 t^{2N+1}$ . Since  $E$  and hence  $u$  and  $\tilde{u}$  vanish at  $t = 0$ ,  $w|_{t=0} = 0$  and

$w$  satisfies

$$(\partial_t + \Delta)w \leq C\epsilon^2 t^{2N} - C(2N + 1)\epsilon^2 t^{2N} < 0.$$

Fix  $T > 0$  and consider  $w$  on  $M \times [0, T]_t$ . If  $w$  has a local maximum for  $z \in M$  and  $t \in (0, T)$  then

$$(\partial_t + \Delta)w > 0,$$

and this is a contradiction. If  $w$  has a maximum at  $t = T$  then  $\partial_t w \geq 0$  at that point and

$$(\partial_t + \Delta)w > 0,$$

which is again a contradiction. Therefore, the maximum of  $w$  occurs at  $t = 0$  and so

$$w \leq C\epsilon^2 t^{2N+1}.$$

This implies

$$u \leq e^T C\epsilon^2 t^{2N},$$

which in turn implies that  $E = O(\epsilon t^N)$  as  $\epsilon, t \rightarrow 0$ , for any  $N \in \mathbb{N}$ . This completes the proof of the theorem.

The leading orders and local behavior of the acc model heat kernel  $H_1$  are summarized in the following table. We have also shown that this is the behavior of the heat kernels for  $(\partial_t + \Delta_\epsilon)$  as  $\epsilon \rightarrow 0$  with error term  $E = O(\epsilon t^\infty)$ .

$\mathcal{H}$ Boundary Face/Region	ACC Heat Kernel Leading Term	Time Variable
$F_{00}$	$H_0(z, z', t')$	$t' = \frac{t}{(\rho_{11})^2}$
$F_{11}$	$(\rho_{11})^2 H_b(z, z', \tau)$	$\tau = \frac{t}{(\rho_{10}\rho_{01})^2}$
$F_{01}$	$(\rho_{01})^2$	
$F_{10}$	$(\rho_{10})^2$	
$C_{0d2}$	$(\rho_{0d2})^{-n}$	
$C_{1d2}$	$(\rho_{1d2})^{-n}$	
$C_{\epsilon d2}$	$(\rho_{\epsilon d2})^{-n}$	
$\{t = 0\}$ off Diagonal	vanishes to infinite order	

♡

**Corollary: ACC Heat Kernel Asymptotics 3.9** *Assume the hypotheses of Theorem 1.8. Then the heat kernels  $H_\epsilon$  have the following asymptotic behavior on the corners acc heat space.*

$\mathcal{H}$ Corner	Contained in $\mathcal{H}$ Boundary face	Leading order
$C_{001}$	$F_{00}$	<i>vanishes to infinite order</i>
$C_{0d2}$	$F_{00}$	<i>leading order <math>-n</math></i>
$C_{0010}, C_{0001}$	$F_{00}$	<i>phg. conormal index set <math>E</math></i>
$C_{1110}$	$F_{00}$	<i>phg. conormal index set <math>F</math></i>
$C_{1111}$	$F_{11}$	<i>vanishes to infinite order</i>
$C_{1d2}$	$F_{11}$	<i>leading order <math>-n</math></i>
$C_{1101}, C_{1110}$	$F_{11}$	<i>vanishes to infinite order</i>
$C_{1110}$	$F_{11}$	<i>smooth up to this face</i>
$C_{\epsilon d2}$	$F_\epsilon$	<i>leading order <math>-n</math></i>
$C_{\epsilon 1}$	$F_\epsilon$	<i>vanishes to infinite order</i>

First we consider  $\epsilon > 0$ . At each of the  $C_{\epsilon d2}$  the acc heat kernel has leading order  $\rho_{\epsilon d2}^{-n}$ . At each of the  $C_{\epsilon 1}$  faces the acc heat kernel vanishes to infinite order.

Next we consider the face  $F_{00}$ . The acc heat kernel has leading term

$$H_0(z, z', t')$$

at  $F_{00}$ , where  $H_0(z, z', t')$  is the heat kernel for  $(M_0, g_0)$  with rescaled time variable  $t' = \frac{t}{(\rho_{11})^2}$ . This rescaled variable vanishes at  $C_{001}$  and  $C_{0d2}$ . The  $C_{001}$  is associated to the  $F_{001}$  in the conic heat space on which  $H_0$  vanishes to infinite order. At  $C_{0d2}$ ,  $H_0$  has leading order  $\rho_{0d2}^{-n}$ . At  $C_{0010}$  and  $C_{0001}$  the conic heat kernel has polyhomogeneous expansion determined by the rank of the vector bundle, the dimension  $n$ , and the eigenvalues of the Laplacian on  $(Y, h)$ . Let  $E$  be the index set for this expansion. The rescaled time variable does not vanish at  $C_{1110}$ . At this face the conic heat kernel has polyhomogeneous expansion determined by  $E$ , and we call the index set for this face  $F$ . These leading orders are summarized in the following table.

Corner in $F_{00}$	Leading order of acc Heat Kernel
$F_{001}$	$\infty$
$F_{0d2}$	$-n$
$F_{0010}$ and $F_{0001}$	$E$
$F_{1110}$	$F$

Next we consider the face  $F_{11}$ . The acc heat kernel has leading term

$$(\rho_{11})^2 H_b(z, z', \tau),$$

with rescaled time variable

$$\tau = \frac{t}{(\rho_{10}\rho_{01})^2}.$$

Then  $\tau$  vanishes at the  $C_{1d2}$  and  $C_{1111}$  corners. At  $C_{1d2}$ ,  $H$  has leading term  $(\rho_{1d2})^{-n}$  and at  $C_{1111}$   $H$  vanishes to infinite order. The rescaled time variable  $\tau \rightarrow \infty$  at the  $C_{1101}$  and  $C_{1110}$  corners. The behavior of  $H$  at these corners is that of the  $b$  heat kernel as  $t \rightarrow \infty$  on the side faces  $F_{10}$  and  $F_{01}$  of the  $b$  heat space, so  $H$  vanishes to infinite order at these faces. At the  $C_{1110}$  corner  $H$  has a smooth expansion with leading order 0 and decays like  $\tau^{-1}$  as  $\tau \rightarrow \infty$ . This behavior is summarized in the following table.

Corner in $F_{11}$	Leading order of acc Heat Kernel
$C_{1111}$	$\infty$
$C_{1d2}$	$-n$
$C_{1101}$ and $C_{1110}$	$\infty$
$C_{1110}$	0

Finally, at the  $F_{10}$  and  $F_{01}$  faces  $H$  vanishes to order 2. The corners of these faces are shared with those of the  $F_{00}$  and  $F_{11}$  faces and the behavior of  $H$  at these corners is determined by the expansion of  $H$  at  $F_{00}$  and  $F_{11}$ .

This completes the proof of the corollary.

♡

The following is a summary of the heat kernel behavior as  $\epsilon \rightarrow 0$  for the heat kernels  $H_\epsilon$  as  $(M, g_\epsilon)$  converge asymptotically conically to  $(M_0, g_0), (Z, g_z)$ .



Corner	Leading Term	Boundary Face	Leading Term at Boundary Face
$C_{1110} \subset F_{00}, F_{11}$	$F_0$	$F_{00}$	$H_0(z, z', t')$
$C_{1111} \subset F_{11}$	$\infty$	$F_{11}$	$H_b(z, z', \tau)$
$C_{1d2} \subset F_{11}$	$-n$	$F_{10}$	$(\rho_{10})^2$
$C_{1101} \subset F_{11}, F_{01}$	$\infty$	$F_{01}$	$(\rho_{01})^2$
$C_{1110} \subset F_{11}, F_{10}$	$\infty$		
$C_{0010} \subset F_{00}, F_{10}$	$E_0$		
$C_{0001} \subset F_{00}, F_{01}$	$E_0$		
$C_{0d2} \subset F_{00}$	$-n$		
$C_{001} \subset F_{00}$	$\infty$		

To construct the full heat kernel the composition rule would be used as follows.

Let

$$H_2 = H_1 - H_1 \circ K$$

and

$$H_j = H_1 + \sum_{l=1}^{j-1} (-1)^l H_1 \circ^l K,$$

where  $H_1 \circ^l K$  is  $H_1$  composed with  $K$ ,  $l$  times. By the composition formula  $H_j$  vanishes to one order higher than  $H_{j-1}$  on the boundary faces of  $\mathcal{H}$ . Then Borel summation gives the existence of  $\tilde{H}$  which has expansion asymptotic to  $\{H_j\}$  and satisfies

$$(\partial_t + \Delta_\epsilon)\tilde{H} = K_\infty(z, z', t, \epsilon),$$

$$\tilde{H}(z, z', t, \epsilon)|_{t=0} = \delta(z - z'),$$

where  $K_\infty$  vanishes to infinite order on all boundary faces of  $\mathcal{H}$ . The difference,  $H_\epsilon - \tilde{H}$ ,

$$H - \tilde{H} = \tilde{K},$$

vanishes on all boundary faces of  $\mathcal{H}$  and satisfies  $(\partial_t + \Delta_\epsilon)\tilde{K}$  vanishes identically on  $\mathcal{H}$ , so by parabolic regularity,  $\tilde{K}$  is also an element of the acc heat calculus and

$$H_\epsilon = \tilde{H} + \tilde{K}.$$

This calculation would provide a full asymptotic expansion of  $H_\epsilon$  as  $\epsilon \rightarrow 0$  uniformly in  $t$ . The leading terms of the expansion at the boundary faces of  $\mathcal{H}$  would be given by the leading terms of the acc model heat kernel.



# Appendix A

## Scalar Heat Kernel on the Exact Cone

The heat kernel for the scalar Laplacian on an exact cone has an expansion in special functions which we study in detail here.

### A.1 Geometric Preliminaries

Let  $(X, g)$  be the exact cone over  $(Y, g_y)$ , a smooth compact  $n - 1$  manifold. Then  $(X, g) \cong \mathbb{R}_x^+ \times Y$  with coordinates  $(x, y)$  and metric

$$g = dx^2 + x^2 g_y.$$

The scalar Laplacian,  $\Delta$  on  $(X, g)$  is

$$\Delta = -\partial_x^2 - \frac{n-1}{x}\partial_x + \frac{1}{x^2}\Delta_y.$$

Let  $(x, y, x', y', t)$  be coordinates on  $X \times X \times \mathbb{R}^+$ . The scalar heat kernel,  $H(x, y, x', y', t)$ , is a tempered distribution on  $X \times X \times \mathbb{R}^+$  satisfying

$$(\partial_t + \Delta)H(x, y, x', y', t) = 0, \quad t > 0,$$

$$H(x, y, x', y', 0) = \delta(x - x')\delta(y - y').$$

Here, as in chapter one, we use the Friedrich's extension of the Laplacian so the heat kernel has the following homogeneity and symmetry properties,

$$H(cx, y, cx', y', c^2t) = c^{-n}H(x, y, x', y', t), \quad H(z, z', t) = H(z', z, t).$$

The conic heat kernel is smooth on the interior of  $X \times X \times \mathbb{R}^+$ . Away from the conic singularity it behaves like the Euclidean heat kernel. To analyze its behavior as  $t \rightarrow 0, \infty$  and near the the conic singularity, we introduce the conic heat space, a manifold with corners obtained from  $X \times X \times \mathbb{R}^+$  by blowing up along the two submanifolds

$$S_{112} = \{(x, y, x', y', t) : x = 0, x' = 0, t = 0, y, y' \in Y\},$$

$$S_{d2} = \{(x, y, x', y', 0) : x = x', y = y'\}.$$

$S_{112}$  is the product of the singular set from the two copies of  $X$  at the initial time  $t = 0$ , and  $S_{d2}$  is the singular set for the initial data, the diagonal of  $X \times X$  at time  $t = 0$ . The submanifolds are blown up parabolically in the direction of the conormal bundle  $dt$ . This blow up replaces  $S_{112}$  by the  $t$ -parabolic normal bundle of  $Y \times Y$  and we call this boundary face  $F_{112}$  with defining function  $\rho_{112}$ . Similarly, the submanifold  $S_{d2}$  is replaced by the  $t$ -parabolic normal bundle of the diagonal at  $t = 0$  away from the first blown up face. This second face is called  $F_{d2}$  with defining function  $\rho_{d2}$ . The resulting manifold with corners will be called  $X_h^2$  and is the *conic heat space*. When lifted to this space, the conic heat kernel is a conormal function with polyhomogeneous expansions at each boundary face and at the corners.

The projective coordinates,  $(s, y, s', y', \tau)$  with  $s = \frac{x}{x'}$ ,  $s' = x'$ , and  $\tau = \frac{t}{(x')^2}$  are convenient because of the symmetry and homogeneity of the heat kernel. In these coordinates the heat kernel is

$$H(x, y, x', y', t) = (s')^{-n}H(s, y, 1, y', \tau).$$

We will study  $H(s, y, 1, y', \tau)$  and use the symmetry and homogeneity properties to describe the heat kernel on the heat space.

## A.2 Analytic Preliminaries

The product structure of the manifold induces to a product decomposition of the heat kernel. Let  $\{\phi_j\}$  be a complete orthonormal eigenbasis for  $\mathcal{L}^2(Y)$  such that

$$\Delta_y \phi_j = \mu_j \phi_j, \quad \|\phi_j\|_{L^2(Y)} = 1,$$

where  $\mu_j \in \sigma(\Delta_y)$ . With respect to this basis  $H$  has the following expansion

$$H(x, y, x', y', t) = \sum_{j \geq 1} \phi_j(y) \phi_j(y') H_j(x, x', t).$$

In the above decomposition, the functions  $H_j$  will be given in terms of special (Bessel) functions. To construct the heat kernel and study its asymptotic behavior on the conic heat space,  $X_h^2$ , we require two technical lemmas.

### A.2.1 Technical Lemmas

**Operator Inequality Technical Lemma A.3** *Let  $(X, g)$  be the exact cone over  $(Y, g_y)$  with scalar Laplacian  $\Delta$ . Assume  $u_j(x, t)$  and  $u_k(x, t)$  are in the Friedrich's Domain of  $\Delta$  for each  $t$  as a function of  $x$ . Let  $\mu_j > \mu_k \gg 0$  and let  $f(x)$  be a non-negative, compactly supported distribution.*

*Then, if  $u_j(x, t)$  and  $u_k(x, t)$  satisfy*

$$(\partial_t - \partial_x^2 - \frac{n-1}{x} \partial_x + \frac{\mu_j}{x^2}) u_j(x, t) = 0,$$

$$u_j(x, 0) = f(x) \geq 0,$$

$$(\partial_t - \partial_x^2 - \frac{n-1}{x} \partial_x + \frac{\mu_k}{x^2}) u_k(x, t) = 0,$$

$$u_k(x, 0) = f(x) \geq 0,$$

the following conclusions hold.

$$u_j(x, t) \geq 0,$$

$$u_j \leq u_k.$$

### Proof

This is a Maximum Principle argument. First we prove the Lemma for smooth initial data. By the hypothesis that  $u_j$  is in the Friedrich's Domain of the conic Laplacian,

$$u_j = O(x^{\frac{2-n}{2}+\delta}) \text{ for some } \delta > 0, \text{ as } \epsilon \rightarrow 0,$$

as in chapter one. Let  $\alpha = \frac{n-1}{2}$ . Then,

$$x^\alpha(-\partial_x^2 - \frac{n-1}{x}\partial_x + \frac{\mu_j}{x^2})x^{-\alpha} = -\partial_x^2 + \frac{(4\mu_j + n^2 - 4n + 2)}{4x^2}.$$

This conjugation kills the linear  $\partial_x$  term. Let

$$c_j = \frac{4\mu_j + n^2 - 4n + 2}{4}.$$

From the hypothesis  $\mu_j \gg 0$ ,  $c_j > 0$ . Let

$$v_j = x^\alpha u_j.$$

Then, since  $\partial_t$  commutes with powers of  $x$ ,

$$x^\alpha(\partial_t - \partial_x^2 - \frac{n-1}{x}\partial_x + \frac{\mu_j}{x^2})x^{-\alpha}v_j = (\partial_t - \partial_x^2 + \frac{c_j}{x^2})v_j = 0 \quad t, x > 0.$$

Note the initial condition satisfied by  $v_j$  is

$$v_j(x, 0) = x^\alpha f \geq 0.$$

Since  $u_j$  is in  $\mathcal{L}^2(x^{n-1}dx)$  and  $u_j = O(x^{\frac{2-n}{2}+\delta})$  as  $x \rightarrow 0$ ,  $v_j$  is in  $\mathcal{L}^2(dx)$

and  $v_j = O(x^{\frac{1}{2}+\delta})$  as  $x \rightarrow 0$ . So the conjugation achieves two goals: it removes the linear term so we may use energy estimates and it eliminates the possibility that  $u_j$  blows up as  $x \rightarrow 0$ . We prove the lemma for  $v_j$  and it will then follow immediately for  $u_j$ . Note that for smooth initial data parabolic regularity implies that  $u_j$  and  $v_j$  are smooth.

Define the energy function

$$E_j(t) = \int_{x \geq 0} v_j^2(x, t) dx.$$

Differentiating with respect to  $t$  gives

$$E_j'(t) = 2 \int_{x \geq 0} \partial_t(v_j(x, t))v_j(x, t) dx = 2 \int_{x \geq 0} (\partial_x^2 v_j(x, t) - \frac{c_j}{x^2} v_j(x, t))v_j(x, t) dx.$$

An integration by parts gives

$$E_j'(t) = -2 \int_{x \geq 0} (\nabla v_j(x, t))^2 + \frac{c_j}{x^2} (v_j(x, t))^2 dx.$$

This is clearly non-positive. There are no boundary terms because  $v_j$  decays as  $x \rightarrow 0$ . Therefore, the  $\mathcal{L}^2$  norm of  $v_j$  is decreasing in  $t$ , so for large  $t$ , the pointwise norm of  $v_j$  is small because  $v_j$  is a smooth function in  $\mathcal{L}^2(dx)$ . This means that for  $\epsilon > 0$  there is some  $t_0$  with  $|v_j(x, t)| < \epsilon$  for all  $(x, t)$  with  $t \geq t_0$ . For each  $t$ ,  $v_j \in \mathcal{L}^2(dx)$  and is smooth so for  $0 \leq t \leq t_0$  there is  $x_0$  with  $|v_j(x, t)| < \epsilon$  for all  $x \geq x_0$ . Any strictly positive or negative extrema must then lie in a finite  $x, t$  rectangle. Because  $v_j(x, t) \rightarrow 0$  as  $x \rightarrow 0$  non-zero extrema must occur for  $x > 0$ , but restricted to the rectangle  $x \leq x_0, t \leq t_0$ .

The differential equation satisfied by  $v_j$  is

$$(\partial_t - \partial_x^2 + \frac{c_j}{x^2})v_j = 0 \tag{A.1}$$

At a local maximum (resp. minimum)  $\partial_t v_j = 0$ , and  $\partial_x^2 v_j \leq 0$  (resp.  $\geq 0$ ). If the maximum or minimum is strictly positive (resp. negative), the left side of A.1 will be strictly positive (resp. negative) while the right side is 0, giving a

contradiction. Therefore,  $v_j$  attains its maximum and minimum when  $t = 0$ . Since  $u_j(x, t) = x^{-\alpha}v_j(x, t)$ , the same is true for  $u_j(x, t)$ . This shows that for positive smooth initial data,  $u_j \geq 0$ .

Now, assume we have  $u_j$  and  $u_k$  as in the statement of the Lemma. Let  $v_j$  and  $v_k$  be defined as above, with  $\mu_j > \mu_k \gg 0$  as in the hypothesis. The same argument applied to  $v_k$  shows  $v_k > 0$ . Let  $v = v_k - v_j$ .  $v$  satisfies

$$(\partial_t - \partial_x^2 + \frac{c_k}{x^2})v = \frac{c_j - c_k}{x^2}v_j, \quad (\text{A.2})$$

$$v(x, 0) = 0.$$

Note that  $\mu_j > \mu_k$  implies  $c_j - c_k > 0$ . Since  $v_j, v_k \rightarrow 0$  as  $x \rightarrow 0$  the same holds for  $v$ . The energy argument shows that any strictly positive or negative extrema for  $v$  occur in some finite  $x, t$  rectangle. For strictly negative local minimum,  $\partial_t v = 0$ ,  $\partial_x^2 v \geq 0$ , and  $v < 0$  would make the left side of A.2 strictly negative, whereas the right side is non-negative. This is a contradiction. Therefore,

$$v_k \geq v_j \implies u_k \geq u_j.$$

We have proven the Lemma under the assumption that the initial data was smooth. To remove this restriction, let  $\{f_\epsilon\}$  be a sequence of smooth, compactly supported non-negative functions so that  $f_\epsilon \rightarrow f$  as distributions. Then, let  $u_{j,\epsilon}$  be the solution with initial data  $f_\epsilon$ . We have shown  $u_{j,\epsilon} \geq 0$ , and since  $u_{j,\epsilon} \rightarrow u_j$  as distributions, this implies  $u_j \geq 0$ . For the second conclusion,  $u_{k,\epsilon} - u_{j,\epsilon} \geq 0$  for each  $\epsilon > 0$  and  $u_{k,\epsilon} - u_{j,\epsilon}$  converges distributionally to  $u_k - u_j$ , so  $u_k - u_j \geq 0$ , which gives the second conclusion:  $u_k \geq u_j$ .

♡

We require one more technical lemma which will be used to control the tail of the heat kernel expansion in special functions.



**Technical Estimate Lemma A.4**

$$\sum_{j=1}^{\infty} \frac{x^{j\frac{1}{n}}}{\Gamma(j\frac{1}{n} + 1)} \leq C e^{2x} \quad \forall x > 0, \quad (\text{A.3})$$

where the constant  $C$  depends only on  $n$ .

First note, for  $n = 1$ , the sum is  $e^x - 1$ . This is the motivation for the estimate. Define

$$R_n(x) = \sum_{j=1}^{\infty} \frac{x^{j\frac{1}{n}}}{\Gamma(j\frac{1}{n} + 1)}.$$

There are no more than  $Cj^{n-1}$  terms between  $\frac{x^j}{\Gamma(j+1)}$  and  $\frac{x^{j+1}}{\Gamma(j+2)}$  where  $C$  depends only on  $n$ . This gives the following estimate,

$$R_n(x) \leq \sum_{j=1}^{\infty} C \frac{j^{n-1} x^j}{\Gamma(j+1)} = \sum_{j=1}^{\infty} C \frac{j^{n-2} x^{j-1}}{(j-1)!}.$$

There is some fixed  $j_0$  depending only on  $n$  such that for  $j \geq j_0$ ,  $j^{n-2} \leq 2^{j-1}$ . This implies

$$R_n(x) \leq \sum_{j=1}^{\infty} C \frac{j^{n-2} x^{j-1}}{(j-1)!} \leq \sum_{j=1}^{\infty} C \frac{(2x)^{j-1}}{(j-1)!} = C e^{2x}.$$

♡

**A.4.1 Special Functions**

Here we recall some useful identities and bounds on Bessel functions. These are from [16] and [29].

We denote by  $J_\nu$  and  $I_\nu$  the Bessel functions of real and imaginary argument, respectively, both of order  $\nu \in \mathbb{C}$ . These are defined as follows.

$$J_\nu(x) = \left(\frac{x}{2}\right)^\nu \sum_{j=0}^{\infty} \frac{(-1)^j \left(\frac{x^2}{4}\right)^j}{j! \Gamma(\nu + j + 1)}. \quad (\text{A.4})$$

$$I_\nu(x) = \left(\frac{x}{2}\right)^\nu \sum_{j=0}^{\infty} \frac{\left(\frac{x^2}{4}\right)^j}{j! \Gamma(\nu + j + 1)}. \quad (\text{A.5})$$

The real and imaginary Bessel functions are related by

$$I_\nu(z) = e^{-\frac{\nu i \pi}{2}} J_\nu(iz). \quad (\text{A.6})$$

The following asymptotics and bounds for the Bessel functions will be useful.

$$J_\nu(x) \sim \frac{x^\nu}{2^\nu \Gamma(1 + \nu)} \quad x \rightarrow 0. \quad (\text{A.7})$$

$$I_\nu(x) \sim \frac{x^\nu}{2^\nu \Gamma(1 + \nu)} \quad x \rightarrow 0. \quad (\text{A.8})$$

$$J_\nu(x) \sim \sqrt{\frac{2}{\pi x}} \cos\left(x - \frac{\nu\pi}{2} - \frac{\pi}{4}\right) \quad x \rightarrow \infty. \quad (\text{A.9})$$

$$|J_\nu(z)| \leq \frac{C|z|^\nu}{2^\nu \Gamma(\nu + \frac{1}{2}) \Gamma(\frac{1}{2})} \quad \forall z \in \mathbb{C}. \quad (\text{A.10})$$

From the representation of the imaginary Bessel function, (A.6), and the estimate on the real Bessel function, (A.10), we have the following global estimate on  $I_\nu$ :

$$|I_\nu(x)| \leq C \frac{|x|^\nu e^{|\nu|}}{2^\nu \Gamma(\nu + 1)} \quad \forall x \geq 0. \quad (\text{A.11})$$

Finally, we will need a rough estimate on the Gamma function, essentially, Stirling's Formula:

$$\Gamma(x) \sim C \frac{x^x}{x^{\frac{1}{2}} e^x} \quad x \rightarrow \infty. \quad (\text{A.12})$$

The expansion of the conic heat kernel from [16] and [29] is,

$$H(x, x', y, y', t) = \sum_{j=0}^{\infty} H_j(x, x', t) \phi_j(y) \phi_j(y'). \quad (\text{A.13})$$

The  $H_j$  are defined in terms of these special functions by (see [16], [29])

$$H_j(x, x', t) = (xx')^{\frac{2-n}{2}} \int_0^\infty e^{-t\lambda^2} J_{\nu_j}(\lambda x) J_{\nu_j}(\lambda x') \lambda d\lambda. \quad (\text{A.14})$$

We also have three additional representations of  $H_j$ .

$$H_j(x, x', t) \sim (xx')^{\frac{2-n}{2}} \frac{\left(\frac{xx'}{4t}\right)^{\nu_j}}{2t\Gamma(\nu_j + \frac{1}{2})\Gamma(\frac{1}{2})}. \quad (\text{A.15})$$

$$H_j(x, x', t) = (xx')^{\frac{2-n}{2}} \exp\left(\frac{-(1+(xx')^2)}{4t}\right) \int_0^\pi \exp\left(\frac{xx' \cos(\theta)}{2t}\right) \sin^{\nu_j}(\theta) d\theta. \quad (\text{A.16})$$

$$H_j(x, x', t) = (xx')^{\frac{2-n}{2}} \frac{1}{2t} \exp\left(\frac{-(1+(xx')^2)}{4t}\right) I_{\nu_j}\left(\frac{xx'}{2t}\right). \quad (\text{A.17})$$

We are now equipped to study the scalar heat kernel on the heat space for the exact cone over  $Y$ .

## A.5 Conic Heat Kernel Asymptotics

We first bound the sup norm of the eigenfunctions  $\phi_j$  on the cross section,  $(Y, h)$ . The bound follows from elliptic regularity and Sobolev embedding.

$$-\Delta_y \phi_j = \mu_j \phi_j \quad \text{on } (Y, g_y) \text{ dimension } n-1.$$

Then, ellipticity of  $\Delta_y$  on  $(Y, g_y)$ , a smooth compact manifold, gives the estimate

$$\|\phi_j\|_{H^{2k}} \leq C (\|\Delta_y \phi_j\|_{H^{2k-2}} + \|\phi_j\|_{H^0}) \leq C (|\mu_j|^k + 1).$$

The Sobolev Embedding Theorem gives

$$\|\phi_j\|_{C^0} \leq C \|\phi_j\|_{H^{\frac{n+1}{2}}} \leq C |\mu_j|^{\frac{n+1}{4}}.$$

We can also use Sobolev Embedding to estimate the norm of  $\partial_y^\alpha \phi_j$  for a multi-index  $\alpha$  of order  $|\alpha| = k$ ,

$$\|\partial_y^\alpha \phi_j\|_{C^0} \leq C \|\phi_j\|_{\mathcal{H}^{k+\frac{n+1}{2}}} \leq C |\mu_j|^{\frac{k}{2} + \frac{n+1}{4}}.$$

So we now have the estimate on  $|\phi_j(y)\phi_j(y')|$ ,

$$|\phi_j(y)\phi_j(y')| \leq C |\mu_j|^{\frac{n+1}{2}}.$$

We also have, for multi-indices  $\alpha$  and  $\beta$  of order  $k$  and  $j$ , respectively, the following estimates on  $|\partial_y^\alpha \phi_j(y)\partial_{y'}^\beta \phi_j(y')|$ .

$$|\partial_y^\alpha \phi_j(y)\partial_{y'}^\beta \phi_j(y')| \leq C |\mu_j|^{\frac{k}{2} + \frac{j}{2} + \frac{n+1}{2}}.$$

Let  $\nu_j = (\mu_j + (\frac{n-2}{2})^2)^{\frac{1}{2}}$ . One final observation is that by Weyl Asymptotics for the compact smooth manifold  $(Y, g_y)$ , we have the estimate

$$|\nu_j|^2 \sim |\mu_j| \sim j^{\frac{2}{n-1}} \quad j \rightarrow \infty.$$

Now we can examine the behavior at the boundary faces of the heat space. There are five boundary faces which meet along edges and corners. The boundary faces are as follows in terms of the coordinates  $(z, z', t) = (x, x', y, y', t)$ .

Face	Locally defined by/blowup of	Local Defining Function
$F_{112}$	Blowup of $S_{112}$	$\rho_{112} = (x^4 + (x')^4 + t^2)^{\frac{1}{4}}$
$F_{d2}$	Blowup of $S_{d2}$	$\rho_{d2} = ( z - z' ^4 + t^2)^{\frac{1}{4}}$
$F_{100}$	Locally defined by $\{x = 0\} - F_{112}$	$\rho_{100}$
$F_{010}$	Locally defined by $\{x' = 0\} - F_{112}$	$\rho_{010}$
$F_{001}$	Locally defined by $\{t = 0\} - (F_{d2} \cup F_{112})$	$\rho_{001}$

Using the representation  $H_j(x, x', t) = (xx')^{\frac{2-n}{2}} \int_0^\infty \exp(-t\lambda^2) J_{\nu_j}(\lambda x) J_{\nu_j}(\lambda x') d\lambda$  and the asymptotics of  $J_{\nu_j}$  as  $x \rightarrow 0$ , the leading order term of  $H$  at  $F_{100}$  is  $(\rho_{100})^{\frac{2-n}{2} + \nu_0}$  and by symmetry at  $F_{010}$  the leading term is  $(\rho_{010})^{\frac{2-n}{2} + \nu_0}$ .

Since the conic heat kernel behaves locally like the Euclidean heat kernel away from the conic singularity, it must vanish to infinite order at  $F_{001}$  and have leading

order  $(\rho_{d2})^{-n}$  at  $F_{d2}$ .

The interesting behavior of the conic heat kernel occurs at  $F_{112}$ . The projective coordinates  $(s, s', y, y', \tau)$  with

$$s = \frac{x}{x'}, s' = x', \tau = \frac{t}{(x')^2}$$

are valid away from  $F_{010}$ . In these coordinates,  $s'$  is a defining function for  $F_{112}$  and the heat kernel becomes

$$H(x, x', y, y', t) = (s')^{-n} H(s, 1, y, y', \tau).$$

We see that the heat kernel has leading order  $(\rho_{112})^{-n}$  at  $F_{112}$ . We now show that the heat kernel is polyhomogeneous at the edges and corners of this face and compute its leading orders.

Consider the corner of  $F_{112}$  and  $F_{100}$  away from  $t = 0$ . This is locally given by  $s \rightarrow 0, \tau \rightarrow 0$ . Using the formula (A.15) for  $H_j$  and the bound on  $\phi_j$  we have the following estimate for the tail of the series

$$\left| \sum_{j \geq J} H_j(s, 1, \tau) \phi_j(y) \phi_j(y') \right| \leq \sum_{j \geq J} \frac{(\nu_j)^{n+1} \left(\frac{s}{4\tau}\right)^{\nu_j}}{2t \Gamma(\nu_j + \frac{1}{2})} s^{\frac{2-n}{2}}.$$

From the estimate on  $\Gamma$  and  $\nu_j \sim \mu_j^{\frac{1}{2}} \sim j^{\frac{1}{n-1}}$ , for  $\tau > \epsilon > 0$ , as  $s \rightarrow 0$ , this tail can be made arbitrarily small uniformly for  $s < 1$ . Therefore,  $H(s, 1, y, y', \tau)$  has a polyhomogenous conormal expansion for  $s \rightarrow 0$  with leading order  $\frac{2-n}{2} + \nu_0$ . By symmetry, this is also the behavior of  $H(1, s', y, y', t)$  at the edge of  $F_{112}$  which meets  $F_{010}$ .

Next, we consider the corners of  $F_{112}$  where  $t \rightarrow 0$  and  $t \rightarrow \infty$ . The representation (A.17) of  $H_j$  gives

$$H_j(s, 1, \tau) = \frac{1}{2\tau} \exp\left(\frac{-(1+s^2)}{4\tau}\right) I_{\nu_j}\left(\frac{s}{2\tau}\right).$$

The bound on  $I_{\nu_j}$  gives the following estimate

$$\left| \sum_{j \geq 1} H_j(s, 1, \tau) \phi_j(y) \phi_j(y') \right| \leq C \frac{s^{\frac{2-n}{2}}}{2\tau} \exp\left(\frac{-(1-s)^2}{4\tau} + \frac{s}{2\tau}\right) \sum_{j \geq 1} \frac{\nu_j^{n+1}}{2^{\nu_j}} \frac{\left(\frac{s}{2\tau}\right)^{\nu_j}}{\Gamma(\nu_j + 1)}.$$

Combining the terms in the exponential,

$$\left| \sum_{j \geq 1} H_j(s, 1, \tau) \phi_j(y) \phi_j(y') \right| \leq C \frac{s^{\frac{2-n}{2}}}{2\tau} \exp\left(\frac{-(1-s)^2}{4\tau}\right) \sum_{j \geq 1} \frac{\nu_j^{n+1}}{2^{\nu_j}} \frac{\left(\frac{s}{2\tau}\right)^{\nu_j}}{\Gamma(\nu_j + 1)}.$$

For  $j$  large  $\frac{\nu_j^{n+1}}{2^{\nu_j}}$  is very small, so we can bound all these terms by one independent constant,  $C$ . Next, we use the Technical Estimate Lemma and the growth of  $\nu_j$ ,

$$\nu_j \sim \mu_j^{\frac{1}{2}} \sim j^{\frac{1}{n-1}}.$$

The Lemma lets us replace the sum with

$$C \exp\left(\frac{2s}{2\tau}\right),$$

giving the final estimate

$$|H(s, 1, y, y', \tau)| \leq C \frac{s^{\frac{2-n}{2}}}{2\tau} \exp\left(\frac{-(1-s)^2}{4\tau} + \frac{s}{\tau}\right).$$

The roots of the quantity in the exponential are  $r_+ = (3 + 2\sqrt{2})$ , and  $r_- = (3 - 2\sqrt{2})$  both of which are positive. As  $s \rightarrow 0$ ,  $s > 0$ , we can assume  $s < r_-$  and  $s < r_+$ . Therefore, the exponential will have rapid decay as  $\tau \rightarrow 0$ . So, at the corner of  $F_{112}$  and  $F_{100}$  as  $\tau \rightarrow \infty$  and also as  $\tau \rightarrow 0$ , the heat kernel vanishes to infinite order. We can also see from the above estimates that  $H$  has a polyhomogeneous conormal expansion at these corners because we may bound the tail of the series in the same way. Note that by symmetry, this asymptotic behavior is mirrored at the corner of  $F_{112}$  and  $F_{010}$  as  $\tau \rightarrow 0, \infty$ .

Finally, we consider  $t \rightarrow \infty$ . Away from  $F_{100}$  and  $F_{112}$ , the behavior of  $H$  is locally that of the Euclidean heat kernel which decays like  $(t)^{-\frac{n}{2}}$  as  $t \rightarrow \infty$ .

Therefore, the same is true for  $H$ .

For  $t \rightarrow \infty$ ,  $x \rightarrow 0$ , we use (A.15) to write  $H$  as the following sum

$$H(x, x', y, y', t) = \frac{(xx')^{\frac{2-n}{2}}}{2t} \sum_{j \geq 1} \frac{\phi_j(y)\phi_j(y')}{4^{\nu_j}} \frac{(xx')^{\nu_j}}{(t)^{\nu_j} \Gamma(\nu_j + \frac{1}{2}) \Gamma(\frac{1}{2})}.$$

For large  $j$ ,  $\frac{\phi_j(y)\phi_j(y')}{4^{\nu_j}} \rightarrow 0$ . This gives

$$\left| \sum_{j \geq J} H_j(x, x', t) \phi_j(y) \phi_j(y') \right| \leq C \frac{(xx')^{\frac{2-n}{2}}}{2t} \sum_{j \geq J} \frac{(xx')^{\nu_j}}{(t)^{\nu_j} \Gamma(\nu_j + \frac{1}{2}) \Gamma(\frac{1}{2})}.$$

The Technical Lemma gives

$$\left| \sum_{j \geq J} H_j(x, x', t) \phi_j(y) \phi_j(y') \right| \leq C(J) \frac{(xx')^{\frac{2-n}{2}}}{2t} \exp\left(\frac{2xx'}{t}\right).$$

Above,  $C(J)$  is a constant that depends only on  $J$  and can be made arbitrarily small for sufficiently large  $J$ . As  $x \rightarrow 0$  and  $t \rightarrow \infty$ , the exponential term converges to 1. The tail of the series can be made arbitrarily small and so there is a polyhomogeneous conormal expansion at this corner with leading order  $\frac{2-n}{2} + \nu_0$  in  $x$  and leading order  $-1$  in  $t$ . Similarly, as  $x' \rightarrow 0$  and  $t \rightarrow \infty$  the heat kernel behaves like  $t^{-1}(x')^{\frac{2-n}{2} + \nu_0}$ .

The following table summarizes the behavior of the heat kernel at the faces and corners of the conic heat space.

Face/Region/Corner of $X_h^2$	Leading Term/Asymptotic Behavior
$F_{100}$	$(\rho_{100})^{\frac{2-n}{2}+\nu_0}$
$F_{010}$	$(\rho_{010})^{\frac{2-n}{2}+\nu_0}$
$F_{001}$	vanishes to infinite order
$F_{112}$	$(\rho_{112})^{-n}$
$F_{d2}$	$(\rho_{d2})^{-n}$
$F_{112}, F_{100}$ corner, $\tau \rightarrow 0, \infty$	Leading order $\frac{2-n}{2} + \nu_0$
$F_{112}, F_{010}$ corner, $\tau \rightarrow 0, \infty$	Leading order $\frac{2-n}{2} + \nu_0$
$F_{112}, F_{100}$ corner, $\tau \rightarrow 0, \infty$	vanishes to infinite order
$F_{112}, F_{010}$ corner, $\tau \rightarrow 0, \infty$	vanishes to infinite order
$F_{112}, \tau \rightarrow \infty$	vanishes to infinite order
$F_{112}, \tau \rightarrow 0$	Leading order $-n$
Interior of $X_h^2$ as $t \rightarrow 0$ and $x, x' \rightarrow 0$	$t^{-1}(xx')^{\frac{2-n}{2}+\nu_0}$

This completes our study of the heat kernel for the scalar Laplacian on the exact cone over  $(Y, h)$ .

♡



# Bibliography

- [1] P. Albin, *The Gauss-Bonnet theorem and Index theory on conformally compact manifolds*. Ph.D. Dissertation, Stanford University, June 2005.
- [2] J. Cheeger, *On the spectral geometry of spaces with cone-like singularities*, Proc. Nat. Acad. Sci. U.S.A. 76 (1979), 2103-2106.
- [3] J. Cheeger, *Spectral Geometry of Singular Riemannian Spaces*. J. Diff. Geo., 18, (1984) 575-657.
- [4] J. Cheeger and T. Colding, *On the structure of spaces with Ricci curvature bounded below, I*. J. Diff. Geo., 46 (1997), no.3, 406-480.
- [5] J. Cheeger and T. Colding, *On the structure of spaces with Ricci curvature bounded below; II*. J. Diff. Geo., 54 (2000), no. 1, 13-36.
- [6] J. Cheeger and T. Colding, *On the structure of spaces with Ricci curvature bounded below. III*. J. Diff. Geo. 54 (2000), no. 1, 37-74
- [7] Y. Ding, *Heat kernels and Green's functions on limit spaces*. Communications in Analysis and Geometry, 10, no. 3 (2002) 475-514.
- [8] K. Fukaya, *Collapsing of Riemannian manifolds and eigenvalues of Laplace operator*. Invent. Math. 87, no. 3, (1987), 517-547.
- [9] M. Gaffney, *A special Stokes' Theorem for complete Riemannian manifolds*, Ann. of Math., **60** (1954), 140-145.

- [10] J. Gil, *Full Asymptotic Expansion of the Heat Trace for Non-Self-Adjoint Elliptic Cone Operators*, Math. Nachr. 250 (2003), 25–57.
- [11] J. Gil and G. Mendoza, *Adjoint of elliptic cone operators*, Amer. J. Math. 125 (2003) 2, 357–408.
- [12] A. Hassell and A. Vasy, *The resolvent for Laplace-type operators on asymptotically conic spaces*. Ann. l’Inst. Fourier 51 (2001), 1299-1346
- [13] A. Hassell, R. Mazzeo and R. Melrose, *A signature formula for manifolds with corners of codimension 2*. Topology, 36 No. 5 (1997), pp. 1055-1075.
- [14] D. Joyce, *Compact Manifolds with Special Holonomy*, Oxford University Press, 2000.
- [15] S. Krantz, *Partial Differential Equations and Complex Analysis*, CRC Press, 1992.
- [16] N. Lebedev, *Special functions and their applications*, Prentice-Hall, Inc., 1965.
- [17] M. Lesch, *Differential operators of Fuchs type, conical singularities, and asymptotic methods*, Teubner Texte zur Mathematik Vol. 136, Teubner-Verlag, Leipzig, 1997.
- [18] J. Lott, *Remark about the spectrum of the  $p$ -form Laplacian under a collapse with curvature bounded below*. Proc. of the AMS 132, p. 11-918, 2003.
- [19] J. Lott, *Collapsing and the Differential Form Laplacian : The Case of a Singular Limit Space*. preprint, <http://www.math.lsa.umich.edu/lott>.
- [20] P. Loya: *Asymptotic Properties of the Heat Kernel on Conic Manifolds*, Israel J. Math.136 (2003), 285–306.
- [21] R. Mazzeo: *Elliptic Theory of Differential Edge Operators I*, Comm. Partial Differential Equations 16 (1991), no. 10, 1615–1664.
- [22] R. Mazzeo and R. Melrose, *Analytic Surgery and the Eta Invariant*. Geom. Funct. Anal. 5 (1995), no. 1, 14–75.

- [23] Patrick T. McDonald, *The Laplacian for Spaces with Cone-Like Singularities*. Massachusetts Institute of Technology, 1990.
- [24] R. Melrose: *The Atiyah-Patodi-Singer Index Theorem* Research Notes in Mathematics, 4. A K Peters, Ltd., 1993.
- [25] E. Mooers: *Heat Kernel Asymptotics on Manifolds with Conic Singularities*, J. Anal. Math. 78 (1999), 1–36.
- [26] S. Rosenberg: *The Laplacian on a Riemannian Manifold*, Cambridge University Press, 1997.
- [27] Robert Seeley and Isadore M. Singer, *Extending  $\bar{\partial}$  to Singular Riemann Surfaces*. J. Geom. Phys. 5 (1988), no. 1, 121–136.
- [28] M. A. Shubin: *Pseudodifferential Operators and Spectral Theory*, Springer, 2000.
- [29] G. Watson *A Treatise on the Theory of Bessel Functions*, Cambridge University Press, Cambridge, England; The Macmillan Company, New York, 1944.